

CTT Series CTRL01

User Manual UM019006E_20200518



Table of Contents

| | |
|---|----|
| Chapter1. Overview | 1 |
| 1.1. Specification | 1 |
| 1.2. Dimensions..... | 2 |
| 1.3. Pin Assignment..... | 3 |
| 1.4. Restoring factory default | 3 |
| 1.5. LED indicator | 3 |
| 1.6. Battery..... | 4 |
| 1.7. Power connection | 5 |
| 1.8. Power Consumption..... | 5 |
| Chapter2. cMT-CTRL01 System Setting | 6 |
| 2.1. Search for cMT-CTRL01's IP address | 6 |
| 2.2. Set in internet browser | 6 |
| 2.3. System Setting..... | 7 |
| 2.3.1. Network | 8 |
| 2.3.2. Date/Time | 8 |
| 2.3.3. HMI Name..... | 9 |
| 2.3.4. History..... | 9 |
| 2.3.5. Email | 10 |
| 2.3.6. Project Management | 10 |
| 2.3.7. System Password | 11 |
| 2.3.8. Enhanced Security | 11 |
| 2.3.9. EasyAccess 2.0 (Optional) | 12 |
| 2.3.10. OPC UA..... | 12 |
| 2.3.11. Communication | 12 |
| Chapter3. Updating Web Package and OS | 15 |
| 3.1 Updating Web Package | 15 |
| 3.2 Updating OS | 15 |
| 3.3 Updating iR Firmware | 17 |
| Chapter4. How to create a cMT-CTRL01 project..... | 19 |
| 4.1. Create a new project..... | 19 |
| 4.2. Download project to cMT-CTRL01 | 20 |
| 4.3. Monitoring OPC UA Client..... | 22 |
| 4.4. On-line/Off-line Simulation..... | 22 |
| Chapter5. Functions supported by cMT-CTRL01 | 24 |
| Chapter6. OPC UA Web Management Interface | 25 |
| 6.1. Introduction | 25 |
| 6.2. Startup / Shut Down | 26 |

| | | |
|------------|--|----|
| 6.3. | Server Settings | 26 |
| 6.4. | Edit Node..... | 28 |
| 6.5. | Certificates | 29 |
| 6.6. | Discovery..... | 30 |
| 6.7. | Advanced..... | 31 |
| Chapter7. | Installing Weintek CODESYS and RemoteIO Package..... | 32 |
| Chapter8. | Connecting cMT-CTRL01 CODESYS | 34 |
| 8.1. | Connecting Through Network..... | 34 |
| 8.2. | Creating CODESYS Project..... | 34 |
| Chapter9. | Creating EasyBuilder Project | 38 |
| 9.1. | Creating Tags..... | 38 |
| 9.2. | Exporting Tags..... | 38 |
| 9.3. | Configuring EasyBuilder | 39 |
| 9.3.1. | Connecting Built-in CODESYS..... | 39 |
| 9.3.2. | Connecting cMT-CTRL01 CODESYS to other HMI | 40 |
| Chapter10. | Connecting cMT-CTRL01 CODESYS to iR Series Modules..... | 41 |
| Chapter11. | Connecting cMT-CTRL01 to iR-ETN | 44 |
| 11.1. | Connecting cMT-CTRL01 to iR-ETN using Modbus TCP/IP..... | 44 |
| 11.2. | Connecting CODESYS and Modbus TCP/IP Gateway..... | 47 |
| 11.2.1. | CODESYS Settings..... | 47 |
| 11.2.2. | Gateway Settings | 48 |
| Chapter12. | Connecting cMT-CTRL01 via EtherCAT | 49 |
| Chapter13. | Removing Weintek Built-in CODESYS..... | 52 |
| Chapter14. | Frequently Asked Questions | 54 |
| 14.1. | Questions Related to CODESYS..... | 54 |
| 14.2. | Questions Related to Downloading cMT CODESYS File | 55 |

Chapter1. Overview

1.1. Specification

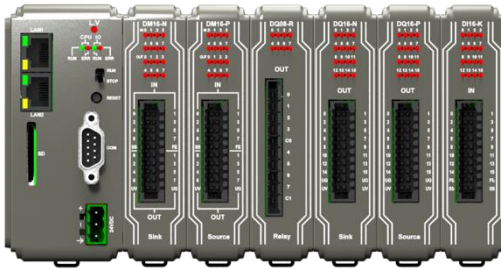

CODESYS PLC with IIoT Gateway

Features

- CODESYS PLC compliant with IEC61131-3
- Fan-less Cooling System
- Built- in 4GB Flash Memory and RTC
- SD Card Slot Supports SD/SDHC Cards
- Rich combination of iR Series Modules

Gateway

- COM2 / COM3 RS-485 2W Supports MPI 187.5K
- Supports OPC UA Server/Client and MQTT
- Modbus TCP/IP Gateway

| | | |
|------------------------|--------------------------|--|
| Memory | Flash | 4 GB |
| | RAM | 512 MB |
| | Data, Memory, Code | 3 MB |
| | Retain area | 16 KB (every minute) (Kept after reboots) |
| | Persistent area | 16 KB (every minute) (Kept after downloads) |
| | File system | 8MB |
| Processor | | Dual-Core 32 bits RISC 1GHz |
| I/O Port | SD Card Slot | SD/SDHC |
| | Ethernet | Ethernet 1: 10/100/1000 Base-T x 1 Ethernet 2: 10/100 Base-T x 1 |
| | COM Port | COM1 RS-232 2W, COM2 RS-485 2W/4W, COM3 RS-485 2W |
| | Local bus | iBus |
| | CAN Bus | N/A |
| CODESYS RTC | Protocol | Modbus TCP/IP Master |
| Power | Input Power | 24±20%VDC |
| | Power Isolation | Built-in |
| | Power Dissipation | Nominal 310mA@24VDC |
| | Current for Internal Bus | Max 2A@5VDC |
| | Current Consumption | 550mA@5VDC |
| | Voltage Resistance | 500VAC (1 min.) |
| | Isolation Resistance | Exceed 50MΩ @ 500VDC |
| | Vibration Endurance | 10 to 25Hz (X, Y, Z direction 2G 30 minutes) |
| Specification | PCB Coating | Yes |
| | Enclosure | Plastic |
| | Dimensions WxHxD | 50 x 109 x 81 mm |
| | Weight | Approx. 0.24 kg |
| | Mount | 35 mm DIN rail mounting |
| Environment | Protection Structure | IP20 |
| | Storage Temperature | -20° ~ 70°C (-4° ~ 158°F) |
| | Operating Temperature | -10° ~ 50°C (14° ~122°F) |
| | Relative Humidity | 10% ~ 90% (non-condensing) |
| Certificate | CE | CE marked |
| Software | | EasyBuilder Pro V6.03.02 or later versions CODESYS V3.5 SP10 Patch 3 or later |

1.2. Dimensions

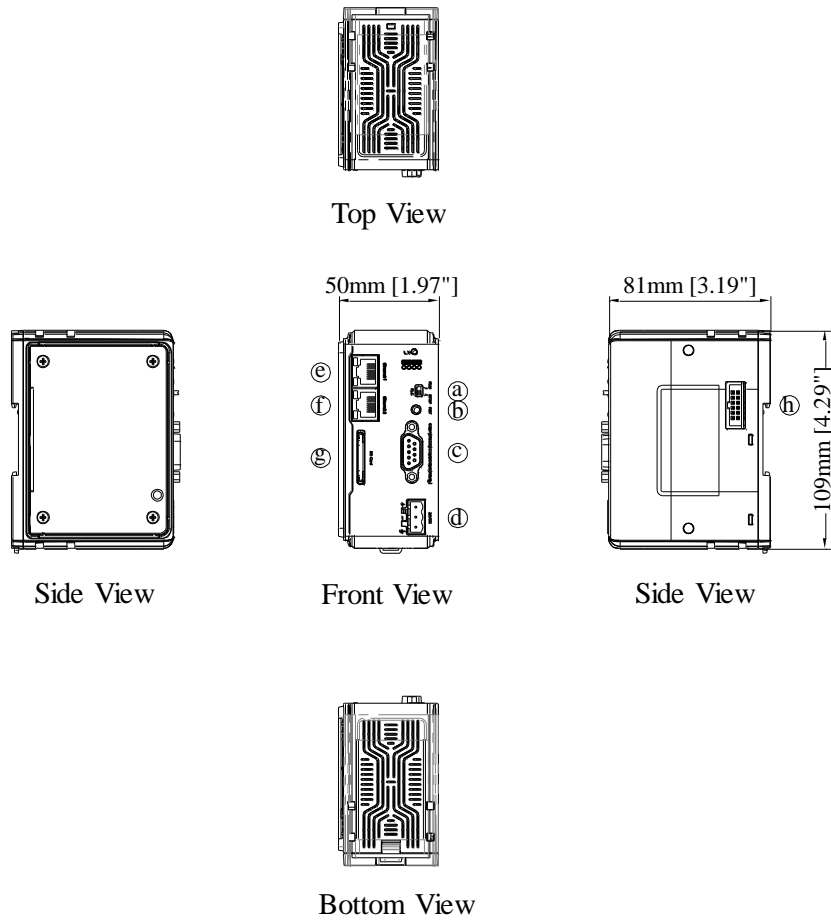

| | | | |
|----------|---|----------|---------------------|
| a | RUN/STOP switch | e | Ethernet 1 |
| b | Reset Button | f | Ethernet 2 |
| c | COM1: RS-232, COM2: RS-485 2W/4W, COM3: RS-485 2W | g | SD Card Slot |
| d | Power Connector | h | Expansion Connector |

1.3. Pin Assignment

COM1 [RS232], COM2 [RS-485 2W/4W], COM3 [RS-485 2W], 9 Pin, Male, D-sub

| PIN# | COM1 [RS-232] | COM2 [RS-485] | | COM3 [RS-485] 2W |
|------|------------------|---------------|-----|---------------------|
| | | 2W | 4W | |
| 1 | | | | Data+ |
| 2 | RxD | | | |
| 3 | TxD | | | |
| 4 | | | | Data- |
| 5 | GND | | | |
| 6 | | Data+ | Rx+ | |
| 7 | | Data- | Rx- | |
| 8 | | | Tx+ | |
| 9 | | | Tx- | |

1.4. Restoring factory default

Press and hold on the Reset button on the unit for more than a certain period of time when the RUN/Stop toggle switch (CODESYS switch) is in STOP state:

| Period of time button is pressed | ERR LED | Action |
|----------------------------------|-----------|--|
| 0~3 seconds | | No action. |
| 3~10 seconds | Blinking | Reboot PLC and Gateway |
| Over 10 seconds | Lights UP | Reset to default. The projects stored in the unit will be cleared and Ethernet 1, Ethernet 2 are reset to default. |

Default settings of cMT-CTRL01:

Ethernet 1: DHCP, CODESYS

Ethernet 2: DHCP, Gateway

Please note that the projects and data stored in the unit are all cleared after pressing the Default button, please download the projects again.

1.5. LED indicator

LED indicators show the status of cMT-CTRL01.

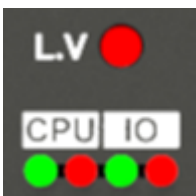

L.V LED

| L.V LED State | Description |
|---------------|------------------|
| OFF | 24V power normal |
| Blinking | Detect 24V power |
| ON | 24V power error |

CPU LED

| Green(RUN) | Red(ERR) | Description |
|------------|----------|---|
| OFF | OFF | CODESYS STOP |
| ON | OFF | CODESYS RUN |
| Blinking | OFF | EBPro or CODESYS scans and the LED of the found unit winks. |
| OFF | ON | CODESYS ERROR |
| Blinking | Blinking | BOOT |

IO LED

| Green(RUN) | Red(ERR) | Description |
|---------------|----------|---|
| OFF | OFF | Power off or no power |
| Fast Blinking | OFF | CODESYS stops |
| Blinking | OFF | IO initiating |
| Blinking | ON | IO initiation error |
| ON | OFF | IO working |
| ON | Blinking | IO module alarm |
| ON | ON | IO communication fault |
| Blinking | Blinking | Exceeds power limitation or too many modules connected. |

Ethernet



Ethernet 1: Assigned for CODESYS by default; and the default IP is DHCP.

If a DHCP server is not available, the IP address will be set to 0.0.0.0.

Ethernet 2: Assigned for Gateway; and the default IP is DHCP.

If a DHCP server is not available, the IP address will be automatically set to 169.254.0.1.

| Color | Status |
|--------|-------------------------------|
| Orange | Ethernet connection status |
| Green | Ethernet communication status |

1.6. Battery

cMT-CTRL01 requires a CR1220 3V lithium battery to keep the RTC running.

Battery Specification: UL Certification Battery, Type CR1220, Rated 3V, Max. Abnormal Charging Current 10mA, Working Temperature: max. 70°C

Battery replacement shall be performed by qualified personnel (Engineer) only and care must be taken when handling lithium batteries. For more information on battery replacement and disposal considerations, please refer to the following link:

http://www.weintek.com/download/MT8000/eng/FAQ/FAQ_103_Replace_Battery_en.pdf

1.7. Power connection

Power: The unit can be powered by DC power only, the voltage range is compatible with most controller DC systems. The power conditioning circuitry inside the unit is accomplished by a switching power supply. The peak starting current can be as high as 500mA.

cMT-CTRL01 voltage range: 24±20% VDC

Power Connector Specifications:

Wire AWG: 24~12

Wiring Conductor Minimum Temperature: 75°C

Screw Torque: 4.5 lbf-in (max.)

Copper conduct only

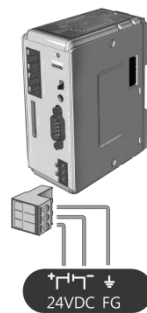

Note: Connect positive DC line to the '+' terminal and the DC ground to the '-' terminal.

1.8. Power Consumption

| Type | Device | Consumption(5V) | Power Supply(5V) |
|-------------|------------|-----------------|------------------|
| CPU | cMT-CTRL01 | 550mA/2.75w | 2A/10w |
| Digital I/O | iR-DM16-P | 130mA/0.65 W | -- |
| | iR-DM16-N | 130mA/0.65 W | -- |
| | iR-DQ08-R | 220mA/1.1 W | -- |
| | iR-DQ16-N | 205mA/1.02 W | -- |
| | iR-DQ16-P | 196mA/0.984 W | -- |
| | iR-DI16-K | 83mA/0.418 W | -- |
| Analog I/O | iR-AQ04-VI | 65mA/0.325 W | -- |
| | iR-AI04-VI | 70mA/0.35 W | -- |
| | iR-AM06-VI | 70mA/0.35 W | -- |
| | iR-AI04-TR | 65mA/0.325 W | -- |
| Motion | iR-PU01-P | 108mA/0.54 W | -- |

Note:

cMT-CTRL01 is the only power supply for the modules in this system. Please consider power requirements when connecting multiple modules. The following is an example.

| Device | Name | Consumption | Power Supply |
|--------|--|----------------|--------------|
| CPU | cMT-CTRL01 | 550mA/2.75w | 2A/10w |
| Module | iR-DM16-P *11 | 130mA*11=1.43A | X |
| System | Power consumption : 550mA + 1.43A = 1.98 A Power supply: 2A > 1.98A | | |

The following Excel file can be used for calculating the current:

https://dl.weintek.com/public/iR/Utility/iR_Current_Calculation_eng.xlsx

Chapter2. cMT-CTRL01 System Setting

Connect cMT-CTRL01's Ethernet 2 via Ethernet cable, and then configure system settings by the following ways.

2.1. Search for cMT-CTRL01's IP address

Launch UtilityManagerEX. On the top-left menu select cMT Series, and then select a function from Reboot, Download, or Upload. cMT-CTRL01 can be found in the IP/HMI Name group box by using the model's IP address, even if the PC or laptop is not on the same network. UtilityManagerEX can find and change cMT-CTRL01's IP address. The following settings can be carried out after obtaining the IP address.

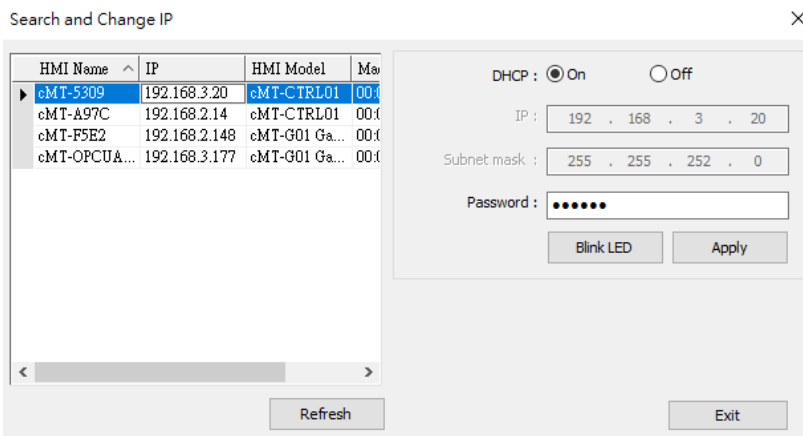
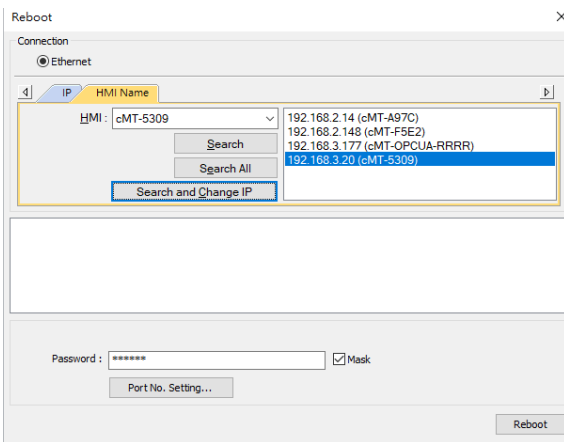

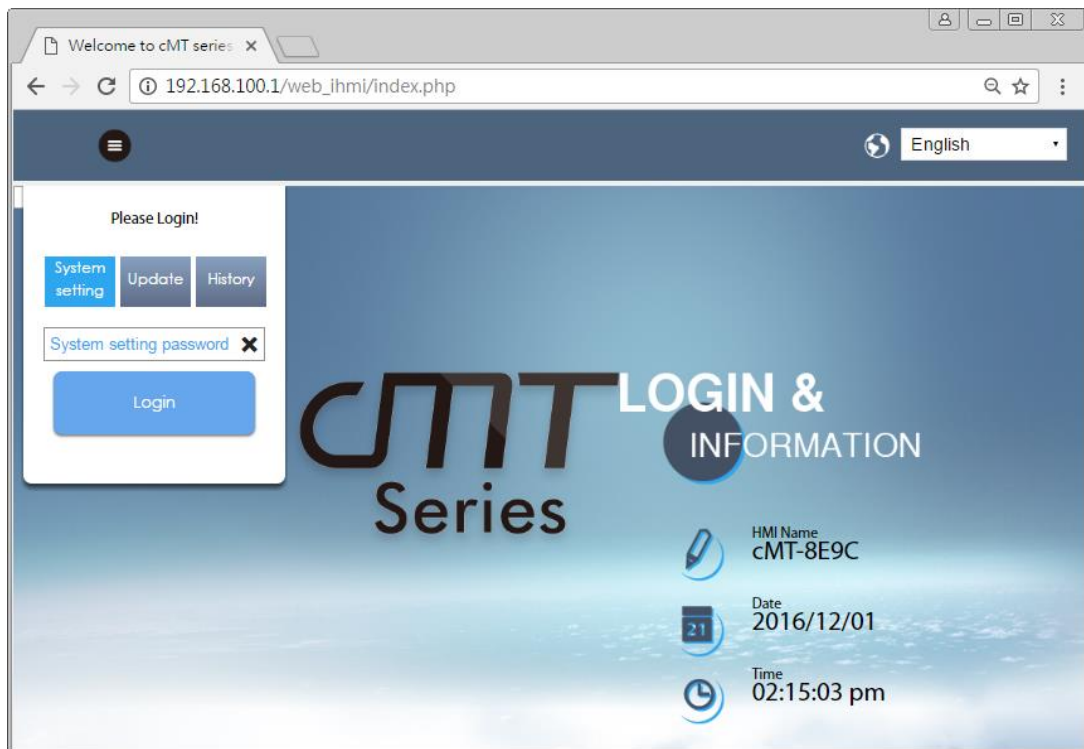

2.2. Set in internet browser

Open internet browser (IE, Chrome, Firefox, Safari), and enter cMT-CTRL01's IP address (e.g. 192.168.100.1) to configure cMT-CTRL01.



cMT-CTRL01 system information is shown in the Login page, and the language used can be changed in this page.

| Icon | Description |
|--|-----------------------|
|  HMI Name cMT-8E9C | Displays HMI name. |
|  Date 2016/12/01 | Displays system date. |
|  Time 02:15:17 pm | Displays system time. |

Please note that by default, Ethernet 2 is assigned for Gateway (DHCP).

2.3. System Setting

The following part introduces cMT-CTRL01 system settings.

Please Login!

System setting
Update
History

System setting password

Login

Three levels of privileges can be found:

[System Setting]: Controls all the settings

[Update]: Controls limited items.

[History]: Downloads history data (Recipes and Event Logs).

2.3.1. Network

Configure Ethernet ports: IP, Mask, Gateway, and DNS.

cMT-CTRL01 is equipped with dual Ethernet ports that can be freely assigned as one of the following:

1. One Ethernet port for CODESYS (Ethernet 1, DHCP) and the other one for IloT Gateway (Ethernet 2 DHCP).
2. Both Ethernet ports for IloT Gateway

Select [Enable CODESYS login] to log in using Ethernet 2's IP address in CODESYS.

The screenshot shows the 'Network' configuration page. On the left is a navigation menu with options: Network, Date/Time, HMI Name, History, Email, Project Management, System Password, Enhanced Security, EasyAccess 2.0, OPC UA, Communication, and CODESYS. The main content area is titled 'Network' and shows 'Ethernet' settings. The 'WAN (LAN 2)' radio button is selected, with a MAC address of 00:0c:26:18:a9:82. Below this, the 'IP Address Ethernet' section has 'Obtain IP address automatically' selected. The IP address is 192.168.2.38, Mask is 255.255.252.0, Gateway is 192.168.1.254, and DNS is 168.95.1.1. At the bottom, the 'Enable CODESYS login' checkbox is unchecked. A 'Save' button is located at the bottom of the form.

2.3.2. Date/Time

Set RTC date and time. Select [Sync. with host] and then click [Save] to synchronize cMT-CTRL01 time with the computer time.

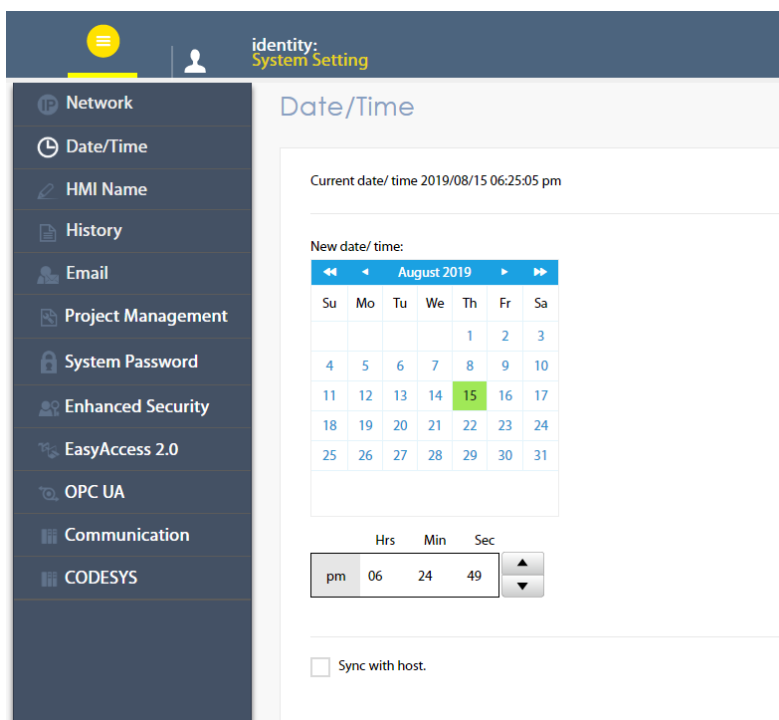

2.3.3. HMI Name

Enter a name to identify the unit.

[Identification light]: The LED indicator of the unit will flash three times when this button is clicked, helping user to find the unit.

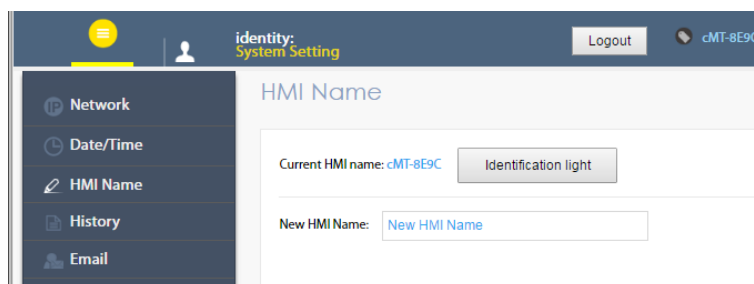

2.3.4. History

This tab offers settings related to historical data.

[Clear]: Clears history data.

[Backup]: Downloads history data in the unit to this computer.

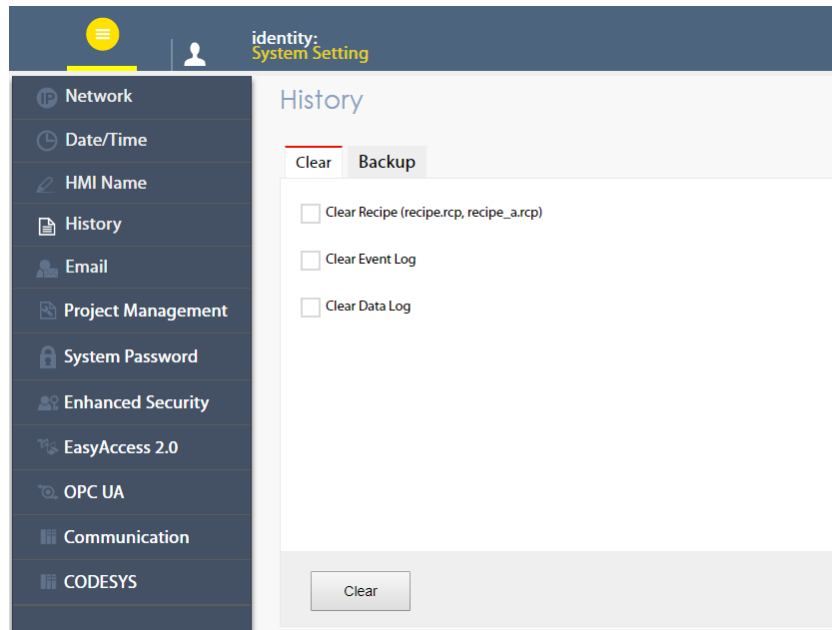

2.3.5. Email

This tab offers settings related to email.

[SMTP]: Configure email server and relevant settings.

[Contacts]: Set email contacts in this tab.

[Update Email Contacts]: Import the email contacts built using Administrator Tools.

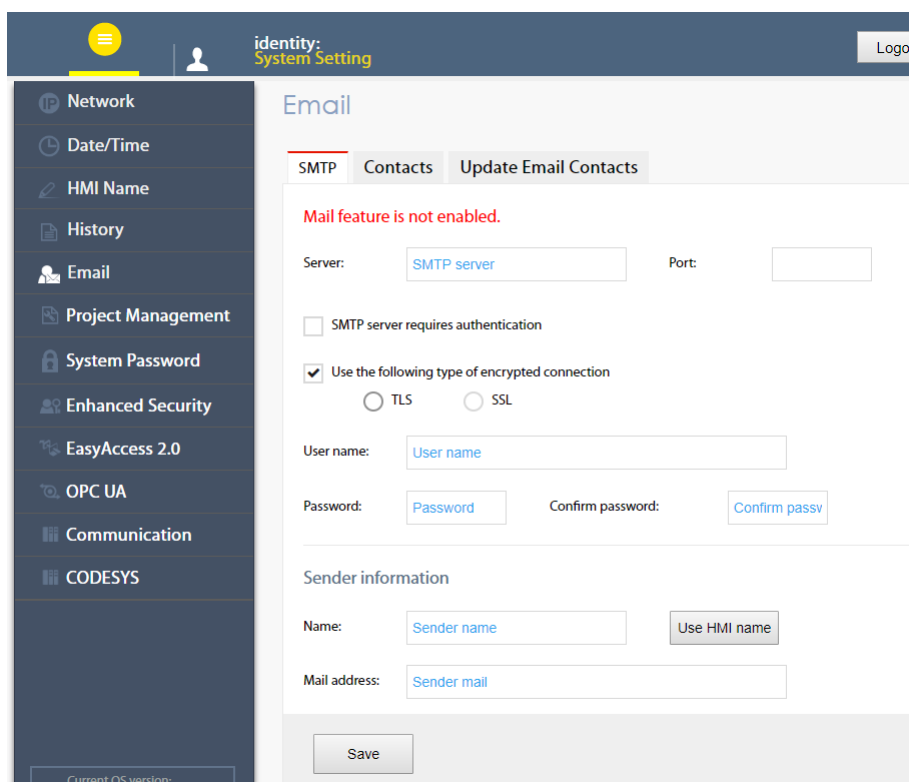

2.3.6. Project Management

This tab offers settings related to project management.

[Restart Project]: Restart cMT-CTRL01 project.

[Update Project]: Upload the project's *.cxob file to cMT-CTRL01.

[Backup Project]: Backup the project file to this computer.

[USB/SD Update]: Use the project file stored in the external device to update the project file on cMT-CTRL01.

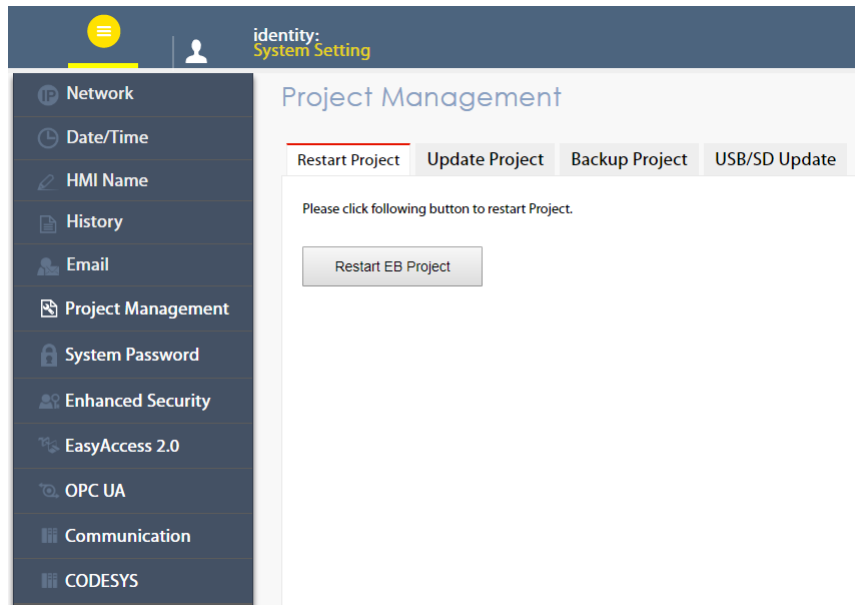

2.3.7. System Password

Set login password and the password for transferring project file.



2.3.8. Enhanced Security

The account settings in this tab determine the accounts that can log in OPC UA.

[Accounts]: Add user or change user password and operable classes.

[Import User Account]: Import the user accounts built in Administrator Tools.

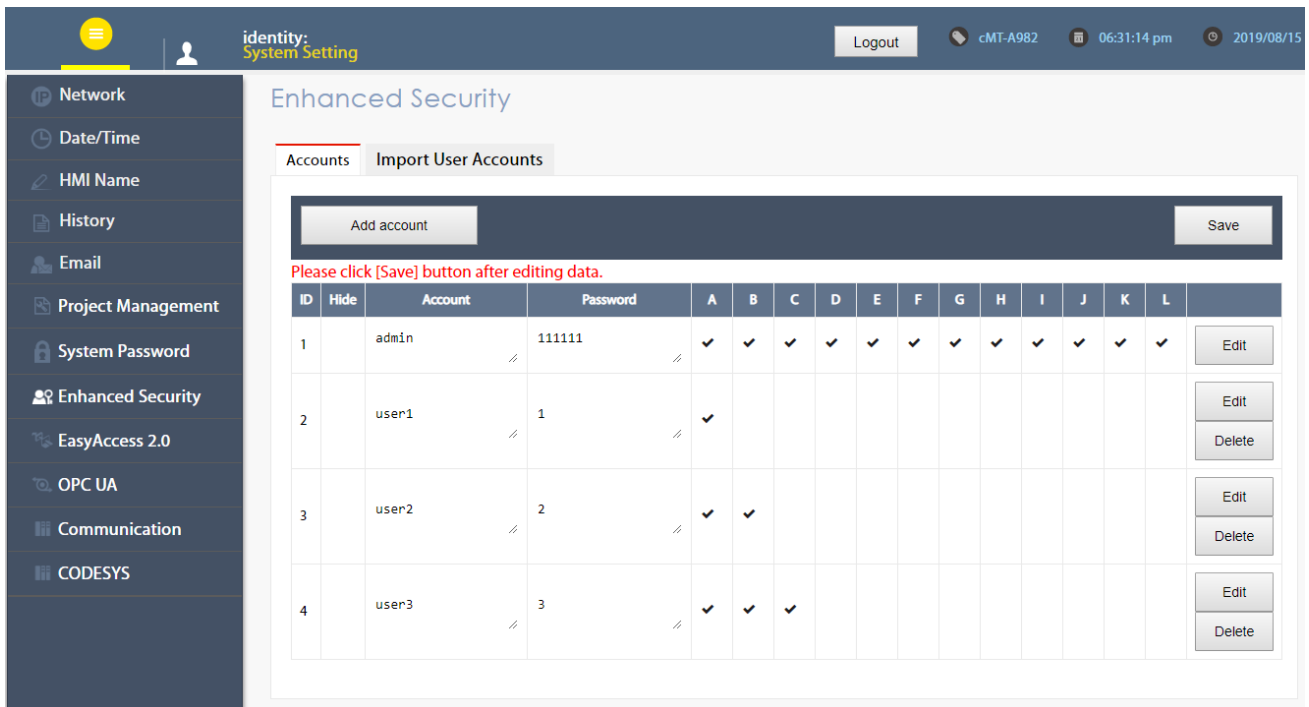

2.3.9. EasyAccess 2.0 (Optional)

This tab shows Hardware Key, EasyAccess 2.0 activate status, and proxy settings. For more information on EasyAccess 2.0, please see EasyAccess 2.0 User Manual.

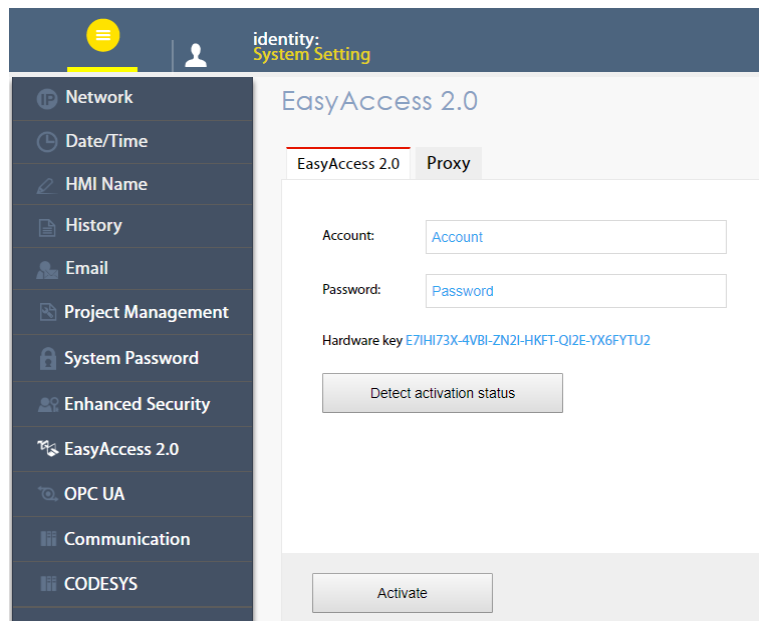

2.3.10. OPC UA

Configure OPC UA settings. Please see “Chapter 6 OPC UA Web Management Interface” in this manual for details.

2.3.11. Communication

This tab displays the communication parameters of the device connected to cMT-CTRL01, and the parameters can be changed in this tab.

identity:
System Setting

- Network
- Date/Time
- HMI Name
- History
- Email
- Project Management
- System Password
- Enhanced Security
- EasyAccess 2.0
- OPC UA
- Communication**
- CODESYS

Current OS version:
 cMT-CTRL01 OS build
 20190731
 Web version: V1.1.1.16

Communication

| Name | Device Type | Interface | Protocol | Default Station No |
|------------------------|--------------------------|---------------------|----------|--------------------|
| ● MODBUS RTU | MODBUS RTU, RTU over TCP | COM 3 (9600,E,8,1) | RS485 2W | 1 |
| ● Mitsubishi FX3U/FX3G | Mitsubishi FX3U/FX3G | COM 2 (38400,E,7,1) | RS485 4W | N/A |
| ● Rockwell DF1 | Rockwell DF1 | COM 1 (9600,N,8,1) | RS232 | 1 |

COM Port Settings (PLC #3) Reset

Interface :

Baud Rate :

Data Bits :

Parity :

Stop Bits :

Timeout (100ms) :

Turnaround Delay (ms) :

Parameter 1 :

Parameter 2 :

Send ACK Delay :

Save

Parameters that can be viewed and modified for a device connected via COM port.

Interface

Baud rate

Data Bits

Parity

Stop Bits

Timeout

Parameter 1

Parameter 2

Send ACK Delay

Parameters that can be viewed and modified for a device connected via Ethernet.

IP Address

Port

Timeout

Turnaround Delay

Parameter 1

Parameter 2

Send ACK Delay

Chapter3. Updating Web Package and OS

cMT-CTRL01 Web Package and OS can be updated through Ethernet. Launch Utility ManagerEX, select [Gateway Series] » [Maintenance] » [cMT-Gateway OS Update].



3.1 Updating Web Package

1. Select an HMI to update OS.
2. Select [Web package] and browse for the source file.
3. Click [Update].

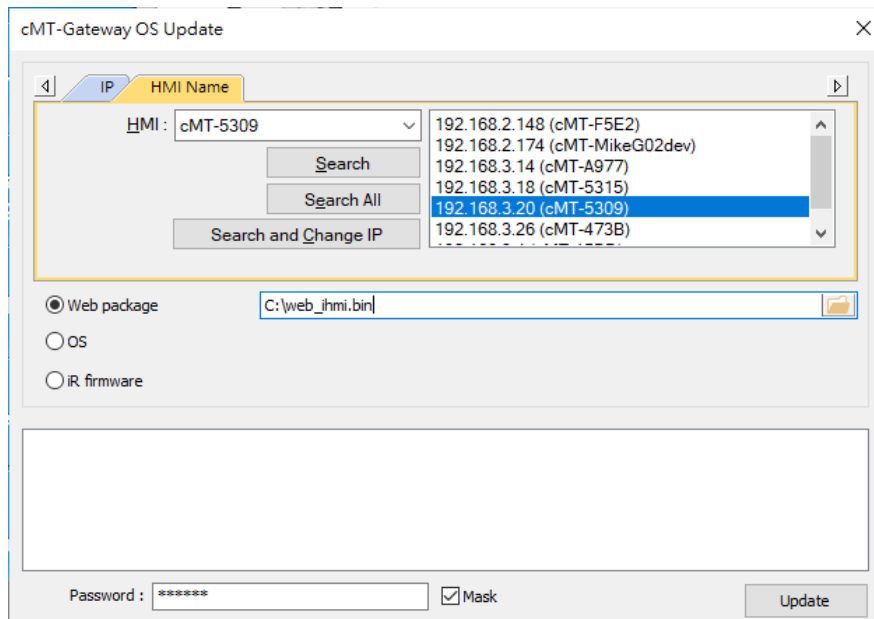

3.2 Updating OS

1. Select a cMT-CTRL01 to update OS.

2. Select [OS], a Warning message shows, please read this message carefully before you click [OK].

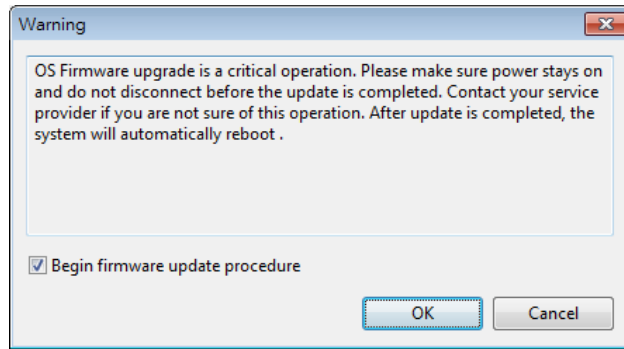

3. If you click [OK], the cMT-Gateway OS Update window opens again, browse for the source file, and then click [Update].

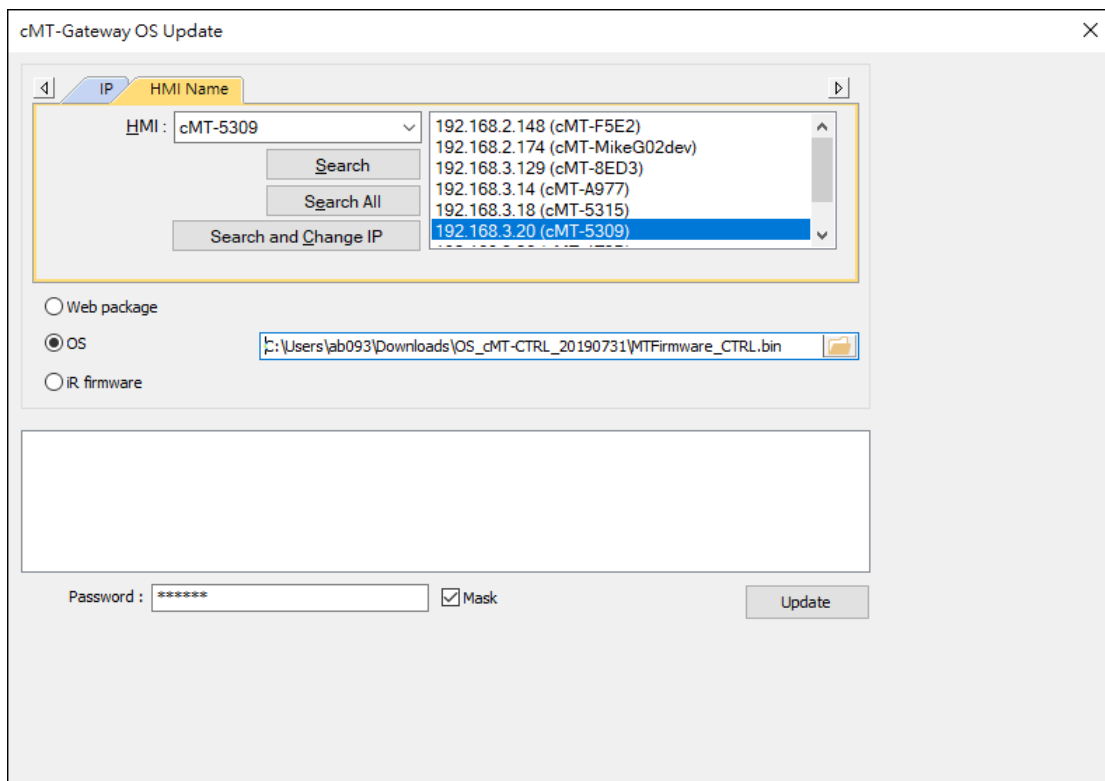

4. The message window below opens, please do not turn off the power while upgrading.

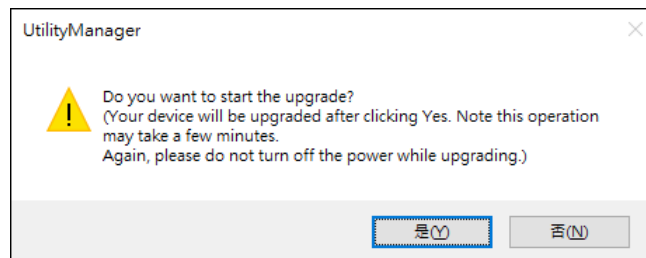

5. When finished, cMT-Gateway OS Update window shows "finished".

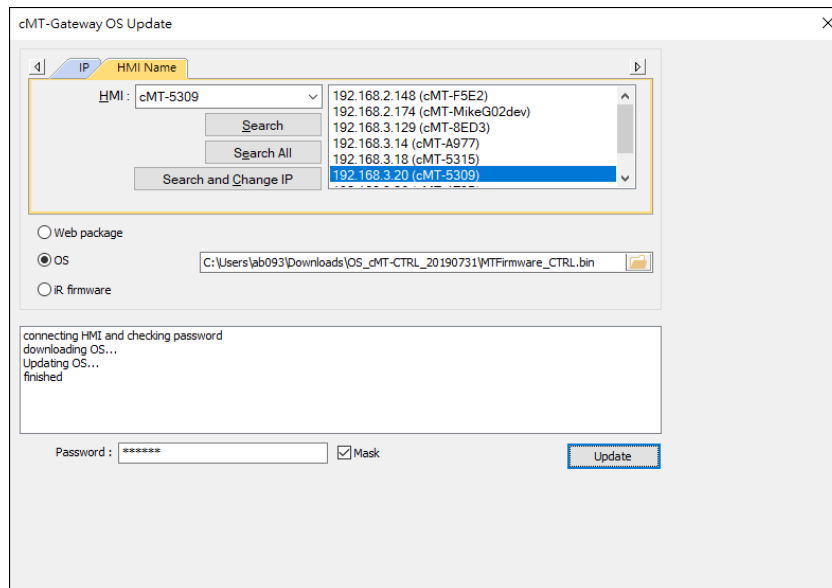

3.3 Updating iR Firmware

When updating iR firmware for cMT-CTRL01, please press and hold the Reset button and power up the unit again.

1. Select a cMT-CTRL01.

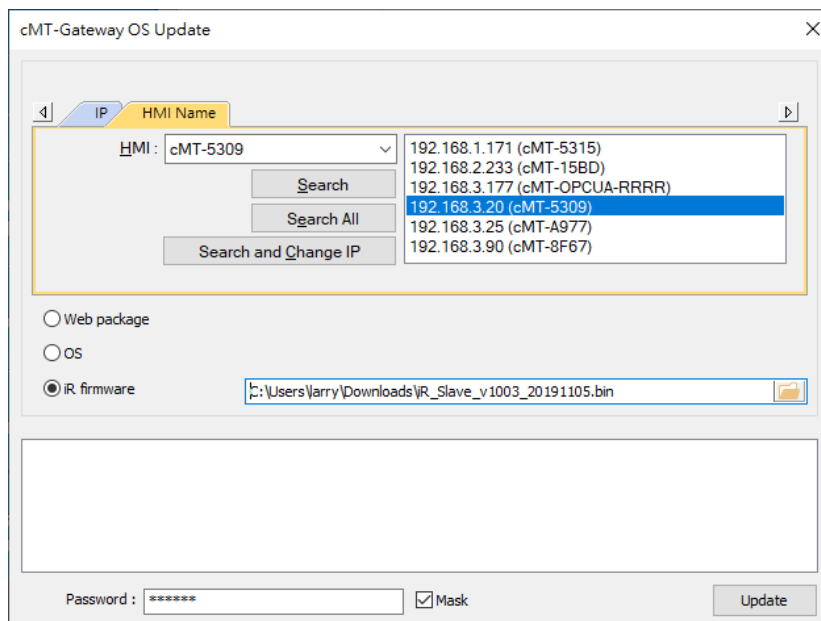

2. Select the bin file and then click [Update].

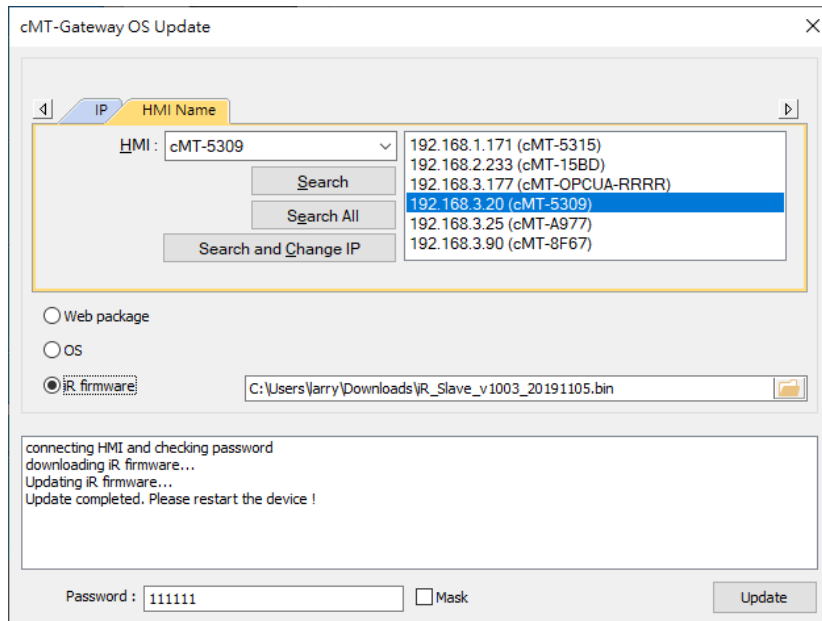

After update, power up the unit again.

In CODESYS log in cMT-CTRL01, and the iR firmware version can be found in the iBus tab.

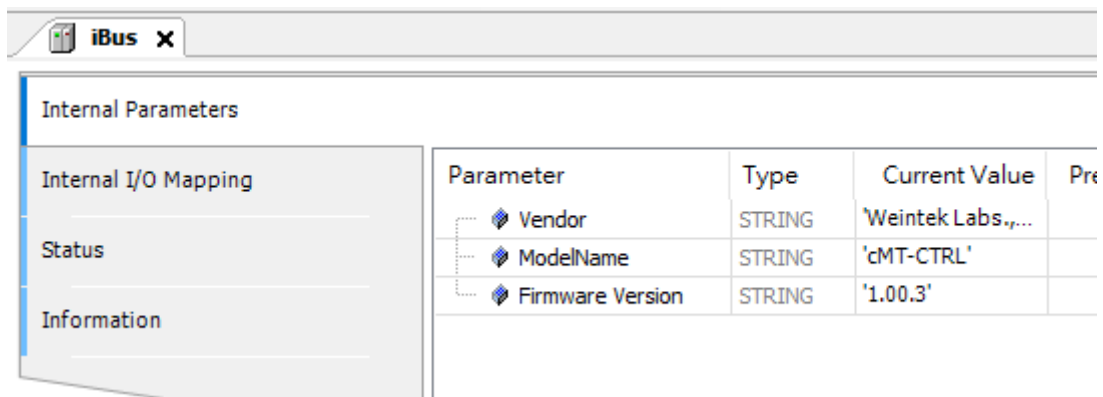

Chapter4. How to create a cMT-CTRL01 project

This chapter explains how to create a project when cMT-CTRL01 is used as an OPC UA Server. The basic steps are:

1. Add a driver into Device List in EasyBuilder Pro.
2. Enable OPC UA Server and designate communication address.
3. Download the project to HMI.

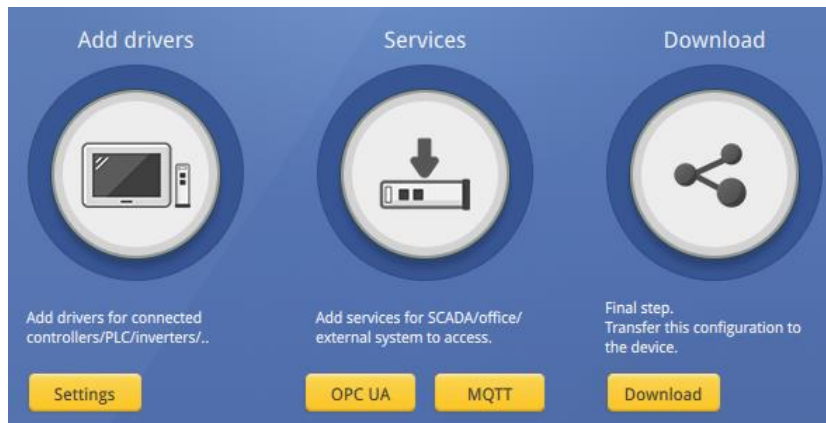

The following explains how to set up OPC UA Server in the project.

4.1. Create a new project

Step 1. Launch EasyBuilder Pro and select a cMT-CTRL01.

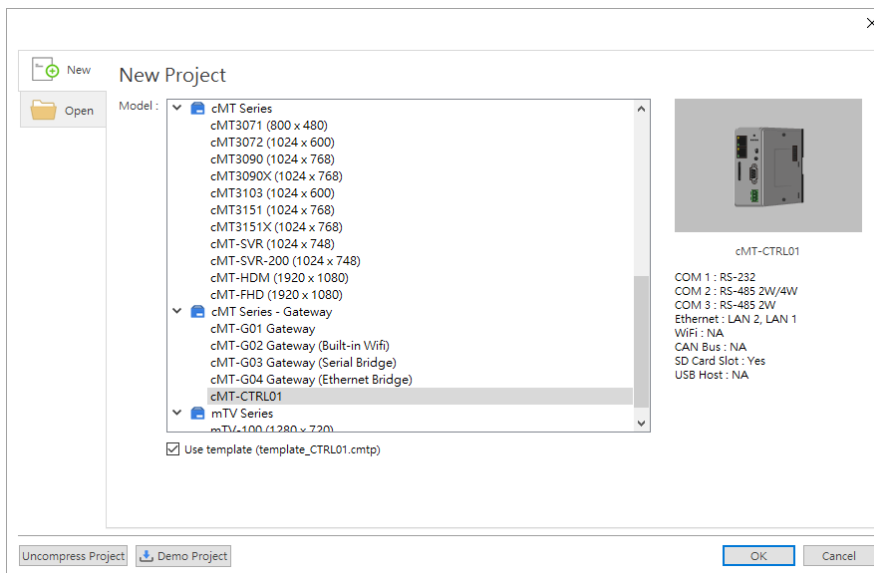

Step 2. Add a device into the list and configure communication parameters.

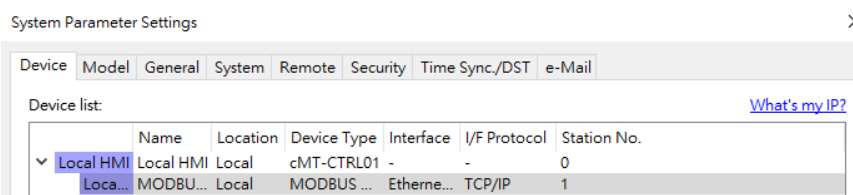

Step 3. Click [IloT/Energy] » [OPC UA Server], and select [Enable] check box to enable OPC UA Server.



Step 4. Click [Tags] of the device and then click [New Tag] to add tags monitored using OPC UA. When finished, click [OK] to leave.

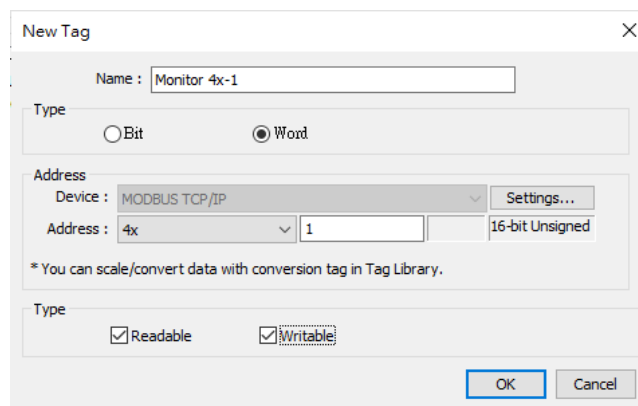

Step 5. Find the created tags in OPC UA Server window. When a large number of tags are used, the tags can be exported as a csv/excel file to be edited and then imported again.

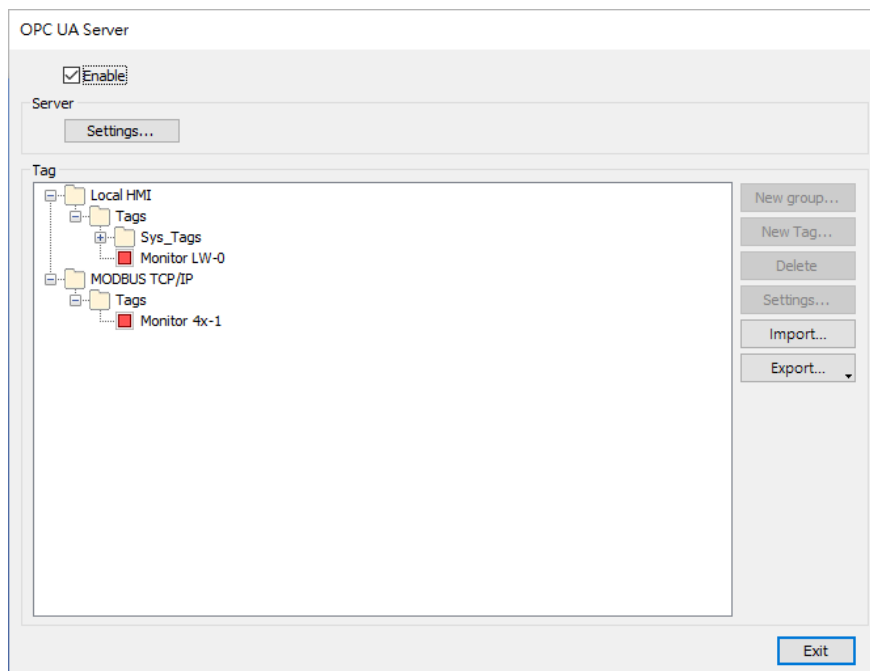

4.2. Download project to cMT-CTRL01

The format of the project file run on cMT-CTRL01 is *.cxob. In EasyBuilder Pro, click [Project] »

[Compile] to compile the project into *.cxob format. When finish compiling, you can download the project to cMT-CTRL01 by two ways.

Way 1: Download using EasyBuilder Pro. Click [Project] » [Download(PC->HMI)], and set HMI IP address. The project can be downloaded via Ethernet.

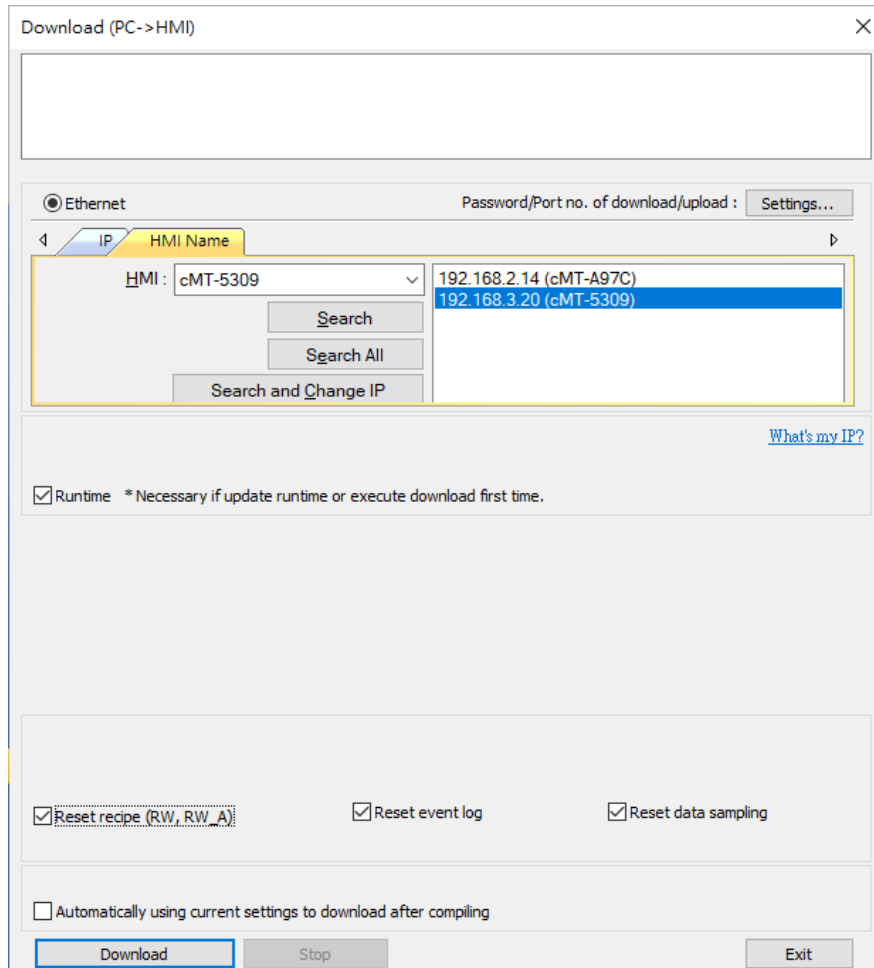

Way 2: Download using website. Open internet browser (IE, Chrome, Firefox), enter cMT-CTRL01's IP address (e.g. 192.168.100.1), click System Setting, enter password, and then configure cMT-CTRL01 settings. Go to [Project Management] page and open [Upload Project] tab to download the project file from the computer to cMT-CTRL01.

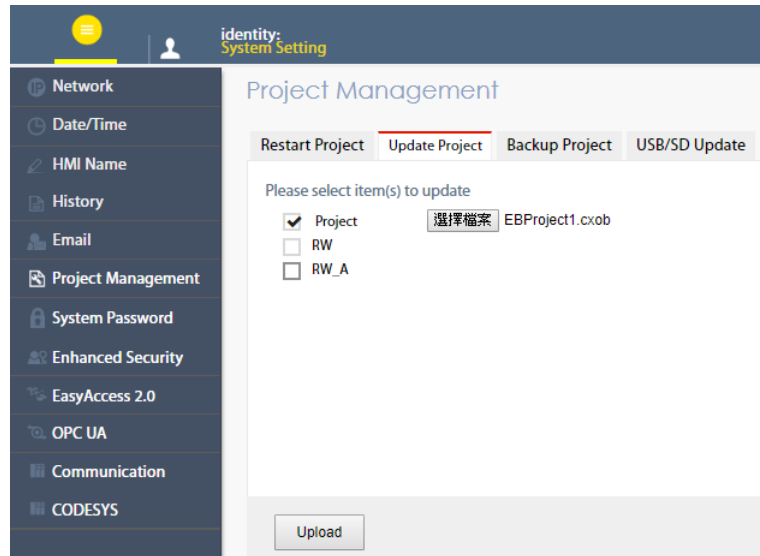

4.3. Monitoring OPC UA Client

After downloading the project file, use OPC UA Client software to connect with cMT-CTRL01 to monitor PLC data.

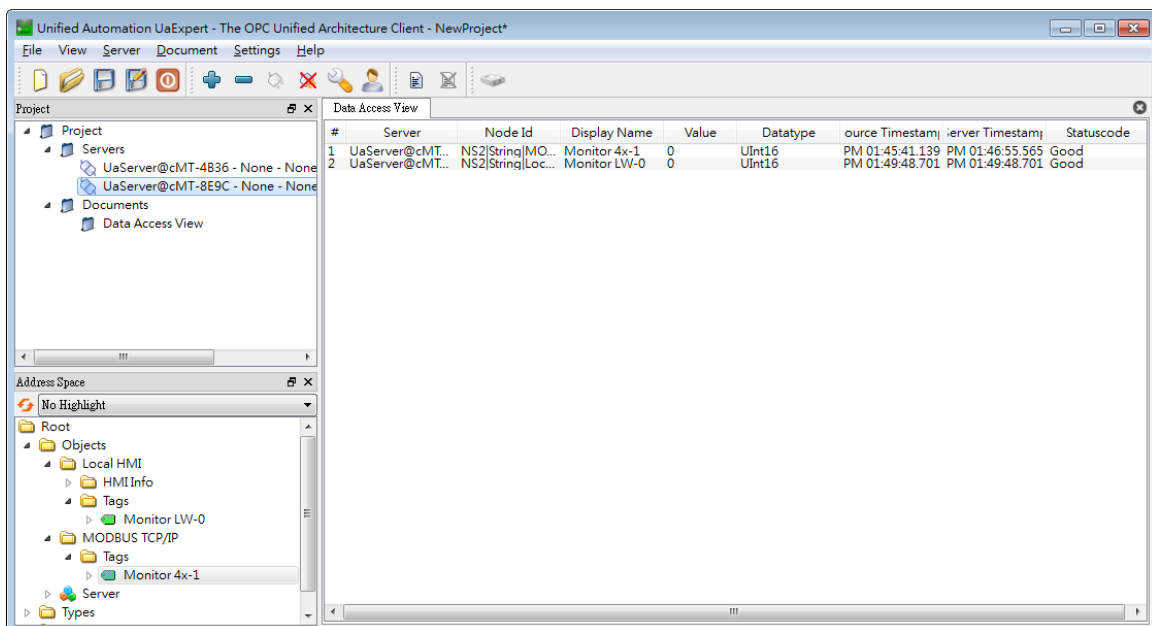

Note: The above is a screenshot of UaExpert. For more information on OPC UA Client software settings, please see OPC UA server manual.

4.4. On-line/Off-line Simulation

Running On-line or Off-line simulation in EasyBuilder Pro helps you examine OPC UA Tag settings. In On-line simulation, cMT Gateway Viewer can read from / write to PLC. Please note that On-line simulation is limited to 10 minutes.

- Step 1. In EasyBuilder Pro click [Project] » [On-line Simulation] / [Off-line Simulation] to open cMT Gateway Viewer window.
- Step 2. Add the tags to be previewed into the Monitor list on the right side.

Step 3. In On-line Simulation, data in PLC tags will also change.

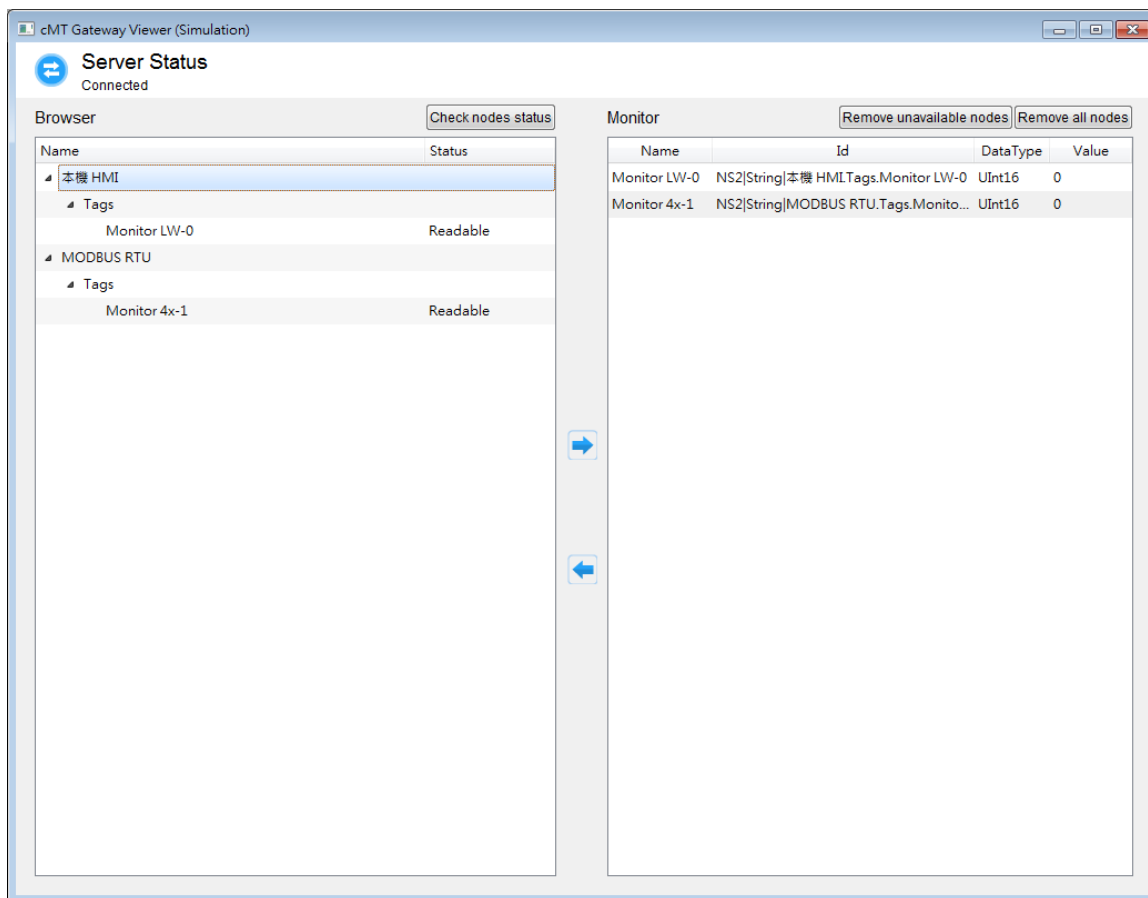

Chapter5. Functions supported by cMT-CTRL01

- OPC UA Server
[UM016009E OPC UA UserManual en.pdf](#)
- EasyAccess 2.0 (Optional)
[UM016001E EasyAccess2 UserManual eng.pdf](#)
- Modbus TCP/IP Gateway
[Chapter 37 MODBUS TCP IP Gateway.pdf](#)
- OPC UA Client
- MQTT Server / MQTT Subscriber / MQTT Publisher
- Administrator Tools
- Time synchronization (NTP)
- Macro
- Project protection
- iE/XE/eMT/mTV communication protocol
- Pass-through
- Data Transfer (Global) object
- Off-line / On-line Simulation
- Recipes (RW, RW_A)
- Event Log (please note that cMT-CTRL01 cannot read history data saved in an external device)
- E-Mail
- Scheduler
- Web interface for managing OPC UA and communication parameters

Chapter6. OPC UA Web Management Interface

6.1. Introduction

cMT-CTRL01 provides a web-based tool for convenient access to OPC UA configurations.

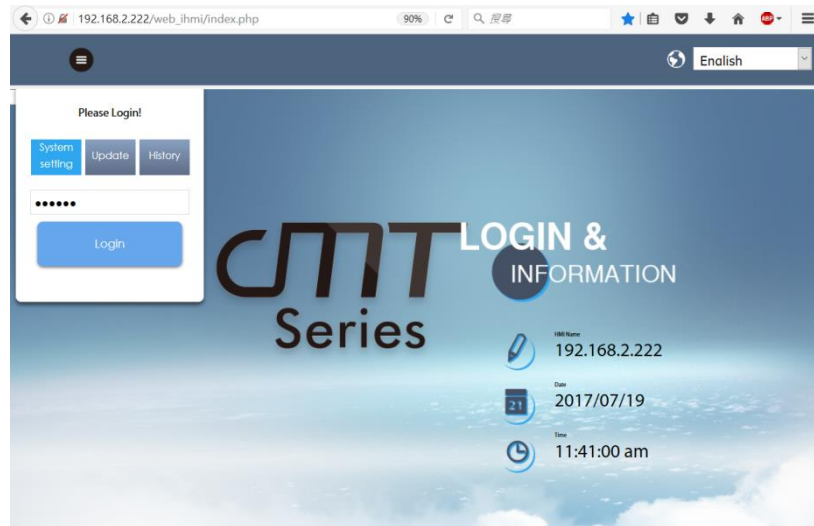

Open cMT-CTRL01's webpage by entering its IP address into the address bar of a web browser. At the entry page, log in with System setting's password. Factory default of the password is 111111. (Suggested resolution: 1024x768 or higher)

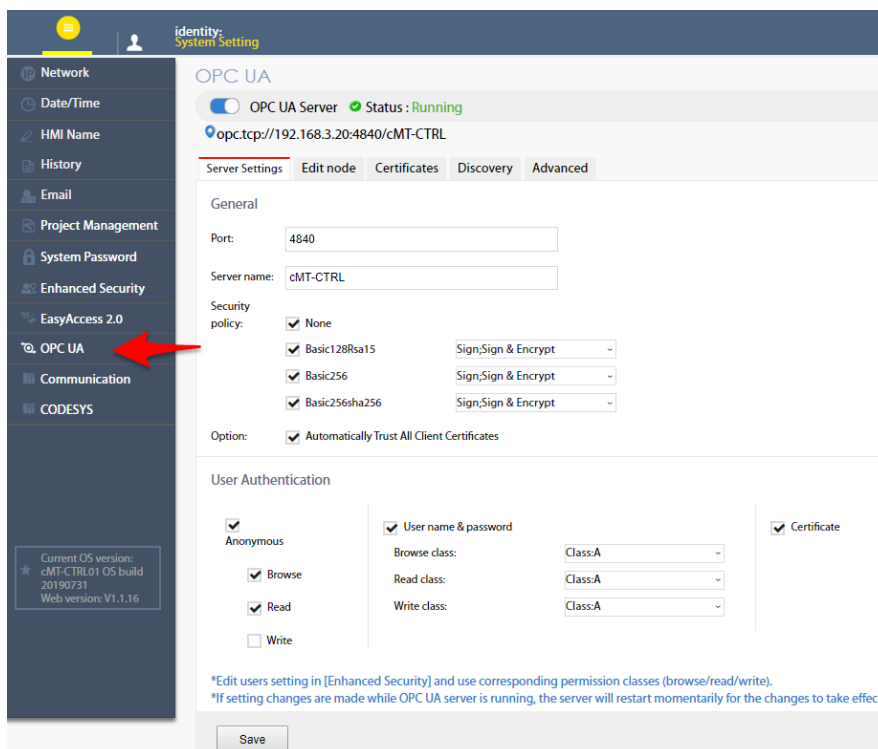

Navigate to the OPC UA configuration page from the context menu on the left.

The OPC UA configuration page consists of a Startup/Shutdown control with status bar and tabbed windows including: Server settings, Edit node, Certificates, Discovery, and Advanced.

Usage of each window tab:

| Tab | Description |
|------------------------|--|
| Server settings | Configure server settings such as port, name, security, user authentication.....etc. |
| Edit node | Manage tags used by OPC UA server. |
| Certificates | Manage certificates used by OPC UA server. |
| Discovery | Manage list of discovery server. |
| Advanced | Advanced options and features. |

6.2. Startup / Shut Down

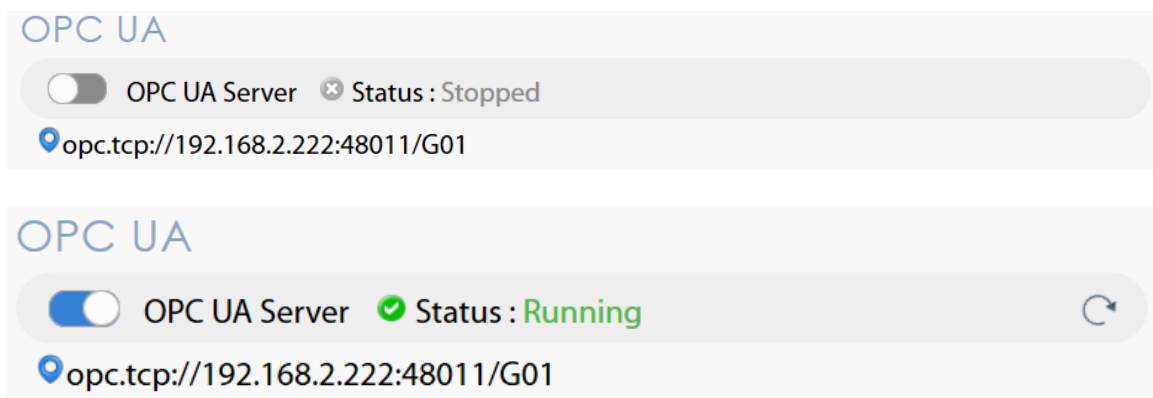

Use the toggle button to start up or shut down the OPC UA server. If there is active client connection, when shutting down, the server will wait for a few seconds before closing off completely.

In addition, both the toggle button and a line of text also indicate the status of the server. The status is refreshed approximately every 10 seconds. An icon on the right  indicates that the status is being refreshed.

Endpoint URL is also displayed for user's reference.

*Whenever a page refresh is desired, use the menu on the left. Avoid using the browser's refresh button to reload a tab as you may be asked to enter the password to log in again.

6.3. Server Settings

The Server settings page shows general configurations of the OPC UA server.

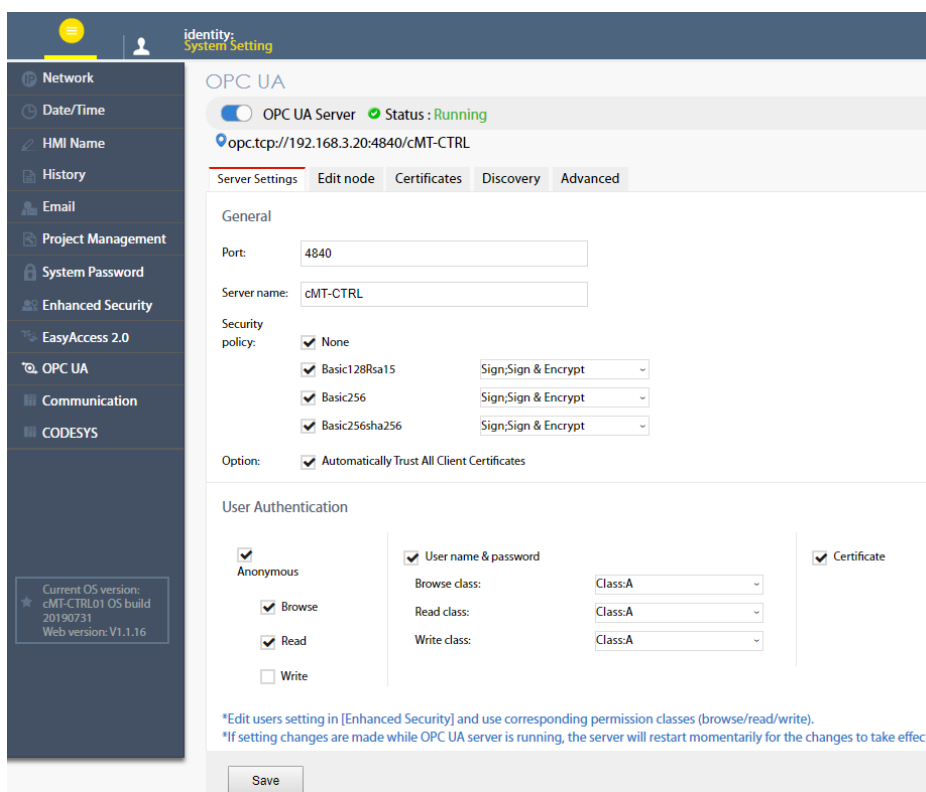

| General | Function |
|------------------------|--|
| Port | Access port of the OPC UA server |
| Server name | Server name of the OPC UA server |
| Security policy | Supported security policies. At least one must be selected. Supported Policy: None, Basic128Rsa15, Basic256, Basic256sha256 Mode: Sign, Sign & Encrypt |
| Option | Automatically Trust all client certificates: by enabling this option, the OPC UA server will trust the certificate from any client connection. |

OPC UA server must be configured with at least one user authentication mode as listed in the following table.

| Authentication | Descriptions |
|---------------------------------|--|
| Anonymous | Allow anonymous client connection. At least one of Browse, Read, or Write modes must be selected. |
| User name & Password | Allow user authentication with username and password. Each access mode, browse, read, and write can be assigned to a user class. User classes are configured in the Enhanced Security mode on the web interface or in EasyBuilder Pro. |
| Certificate | User authentication with X.509 certificate |

After completing settings, click the Save button to save the changes. OPC UA server will shut down momentarily and then restart for the changes to take effect.

6.4. Edit Node

In this page, the user can view and manage the tags currently available in the OPC UA server. New nodes and groups can be added, while existing nodes and groups can be edited or deleted. For ease of navigation, detail information of the currently selected node/group is displayed on the right. After completing settings, it is necessary to click the Save button to save the changes. OPC UA server will shut down momentarily and then restart for the changes to take effect. Changes will be lost if one exits this page without saving.

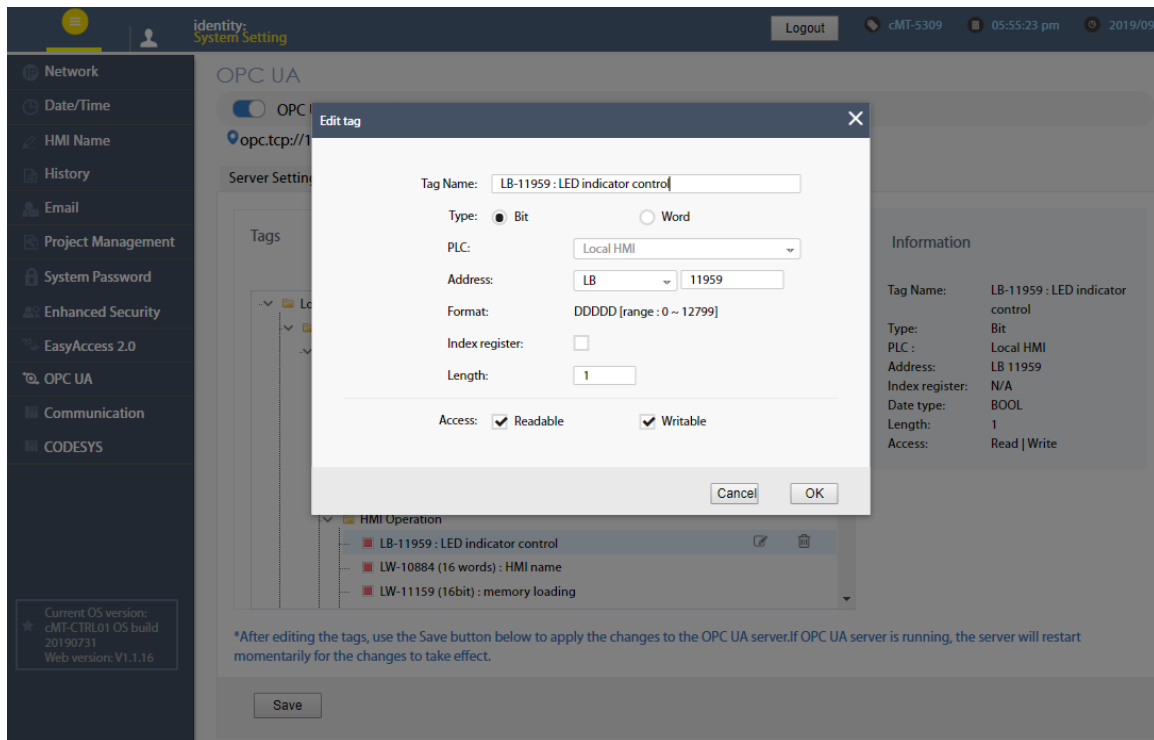

Note that all modifications can only be made for existing drivers. It is not possible to change or add other drivers that are not already available. It is also not possible to edit the nodes used by tag PLCs*.

*Tag PLCs are characterized by their use of name tags as device memory address as opposed to using device name with indices. Examples of tag PLCs include: BACnet, Rockwell Free Tag Names , Siemens S7-1200/1500 Symbolic Addressing,...etc.

6.5. Certificates

In this page, the user can manage certificates and revocation lists of the OPC UA server. Use the dropdown menu to access each page.

If “Automatically Trust All Client Certificates” (in the Server settings tab) option is not enabled, OPC UA server will reject all client connections and place their certificates in the untrusted list. User may manually “trust” them in this page. Use the reload button  to repopulate the list of certificates if necessary.

Similarly, currently trusted certificates can be manually rejected on the same page.

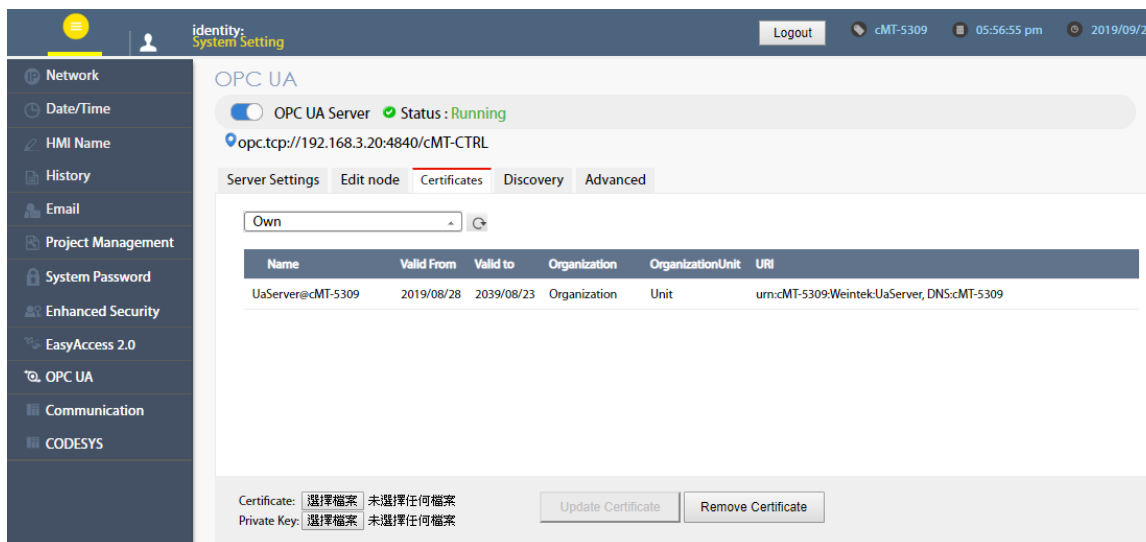

| Page | Description |
|------------------------------------|---|
| Trusted Clients | Lists of trusted/rejected client certificates on the server. Supported operation: Trust/Reject, Remove, Import, Export. |
| Trusted Users | Lists of trusted/rejected user certificates on the server. Supported operation: Trust/Reject, Remove, Import, Export. |
| Own | Server's own certificate. Supported operation: Update, Remove. When updating own certificate, matching certificate and Private Key must be uploaded together; otherwise, update will fail. A self-signed, 20-year validity certificate will be generated automatically if own certificate is absent when server starts up. |
| Trusted Client Issuers | List of trusted client issuer certificates. Supported operation: Import, Remove, Export. |
| Trusted User Issues | List of trusted client issuer certificates. Supported operation: Import, Remove, Export. |
| Certificate Revocation List | Certificate revocation lists for client, user, client issuer, and user issuer. Supported operation: Import, Remove, Export |

6.6. Discovery

OPC UA server can register itself with Local Discovery Servers. In this page, the user can maintain the list of discovery servers that OPC UA server will register with during startup. Should the discovery server be unavailable during server shutdown, the shutdown process will be slightly delayed.

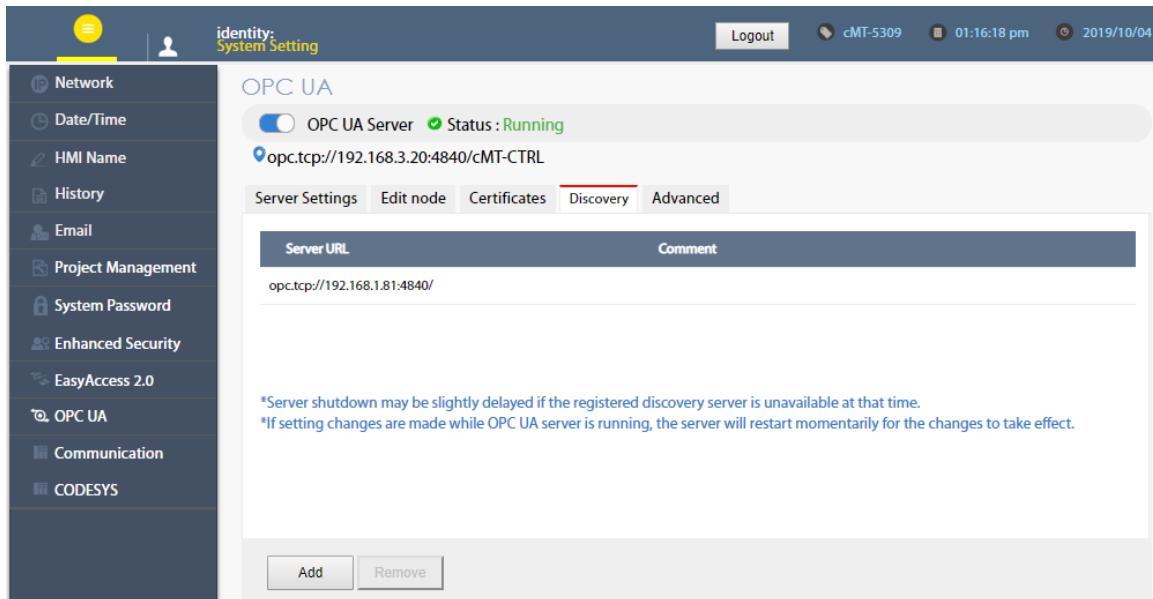

After completing settings, click the Save button to save the changes. OPC UA server will shut down momentarily and then restart for the changes to take effect.

6.7. Advanced

Additional settings can be configured in the Advanced tab. The user can set the trace logging level and specific startup behavior of the OPC UA server. Furthermore, the trace log can be downloaded.

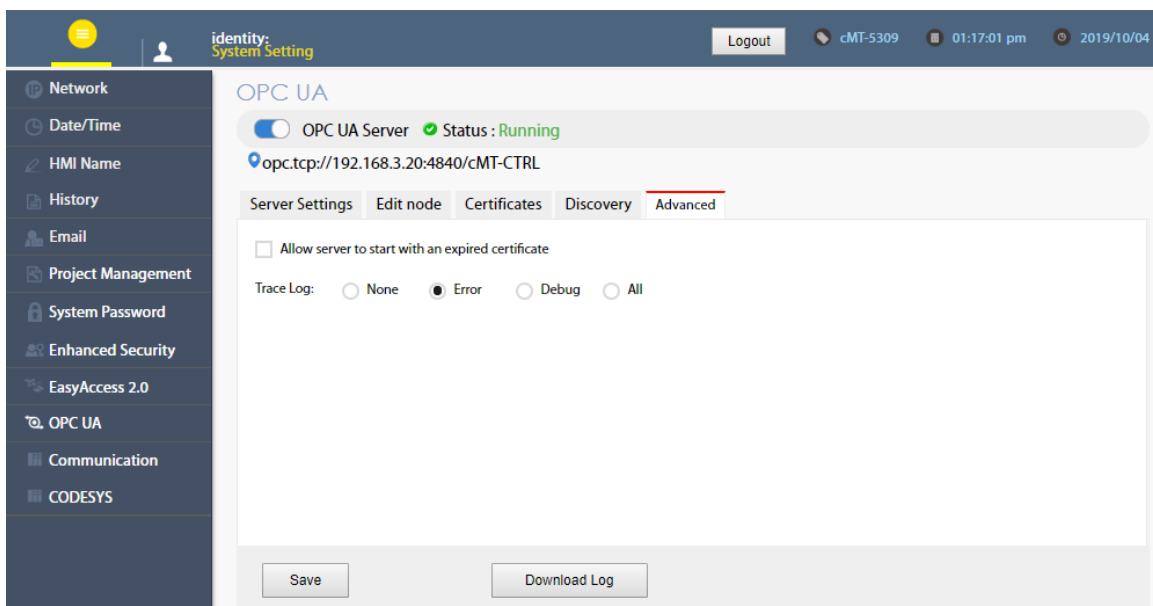

After completing settings, click the Save button to save the changes. OPC UA server will shut down momentarily and then restart for the changes to take effect.

Chapter7. Installing Weintek CODESYS and RemoteIO Package

Installing Weintek CODESYS and Remote IO Package allows users to easily create a cMT+CODESYS project in CODESYS software. Please find the Package file we prepared and follow these steps for quick installation.

1. Firstly, get a copy of Weintek CODESYS and RemoteIO Package file.



2. On your PC, right-click the mouse button and select [Open with CODESYS Package Manager].

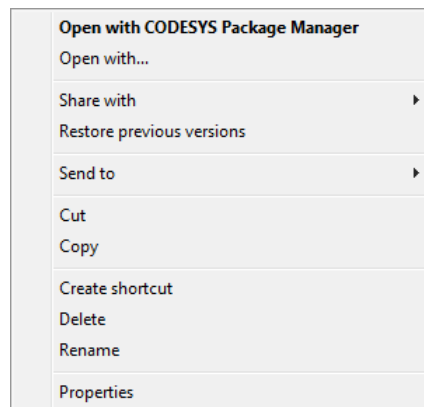

3. Select Complete Setup or Typical Setup (you may select any of these setup types since the components used by Weintek Built-in CODESYS exist in both types.)

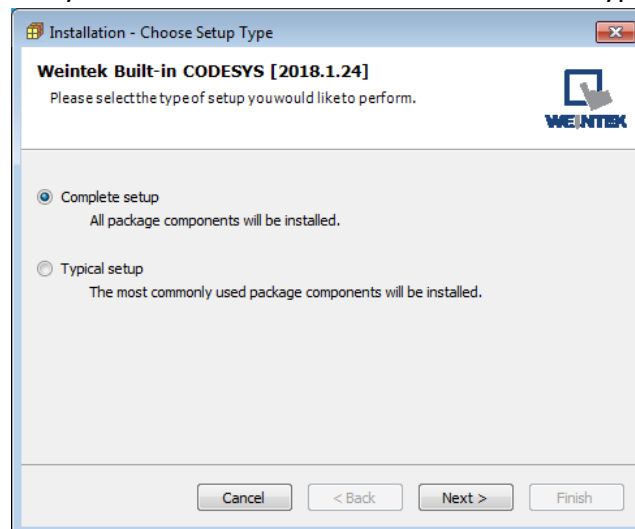

4. Click [Next] when seeing the following message.

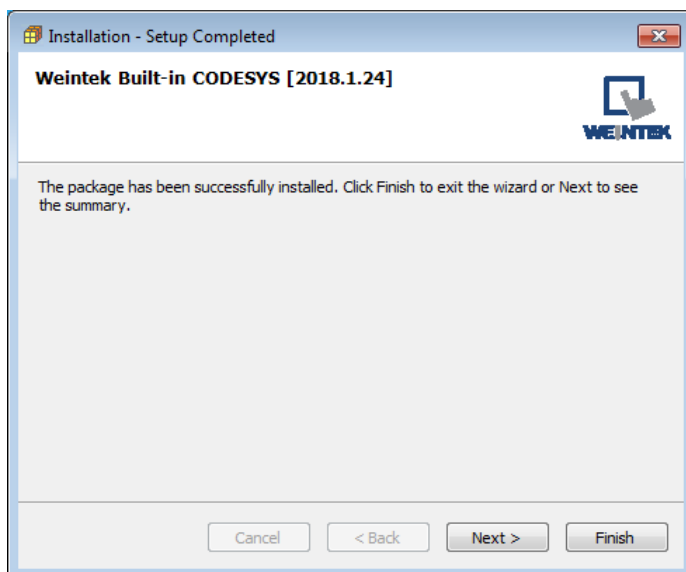

- 5. The installed component will be shown in the installation summary.

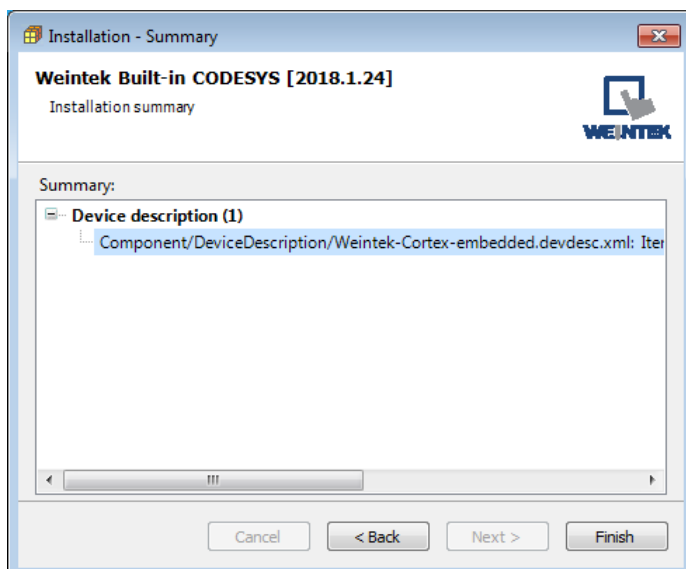

Chapter8. Connecting cMT-CTRL01 CODESYS

8.1. Connecting Through Network

The PC can directly connect with CODESYS via Ethernet 1 when:

- The PC and cMT-CTRL01's Ethernet 1 & 2 are all connected to the same router.
- The PC is directly connected to cMT-CTRL01's Ethernet 1 using an Ethernet cable.

When the PC is connected to cMT-CTRL01's Ethernet 2, please follow the setting steps below.

1. Find cMT-CTRL01's IP address in the way explained in Chapter 2.1.
2. Open internet browser (IE, Chrome, Firefox, Safari), enter cMT-CTRL01 Gateway IP address (e.g. 192.168.100.1), and then configure cMT-CTRL01 settings.
3. Open CODESYS page to see the IP address. By default DHCP is used for cMT-CTRL01 CODESYS IP.

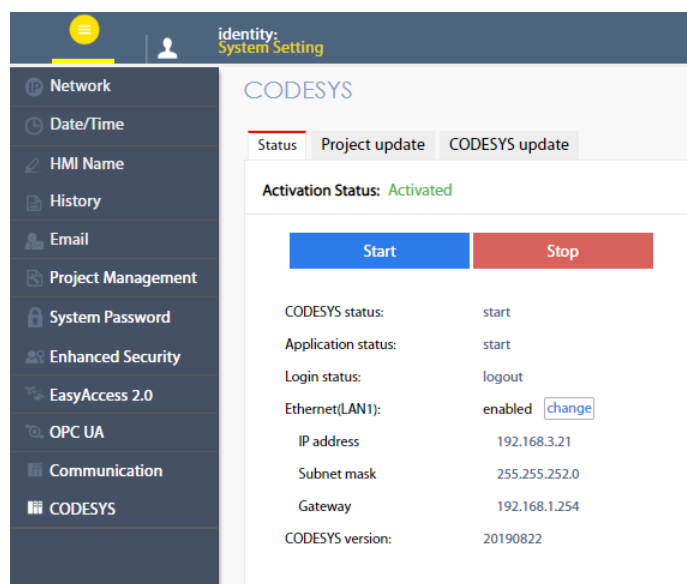

4. When Ethernet 1 is assigned for Gateway, please see Chapter 2.3.1 Network and select [Enable CODESYS login]. With this option selected, Ethernet 2's IP address can be entered in CODESYS for login.

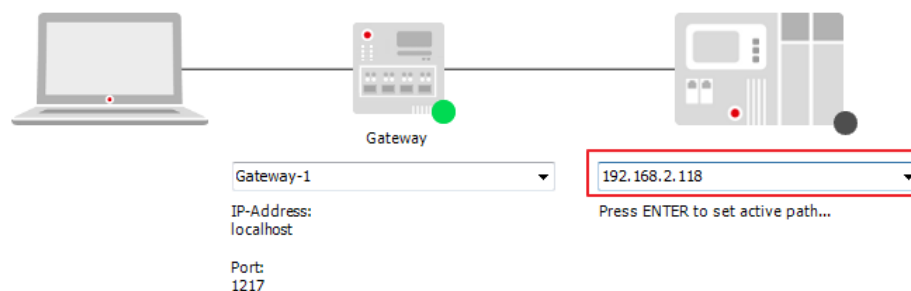

8.2. Creating CODESYS Project

1. Launch CODESYS V3.5 and click [File] » [New Project], and then select [Standard project]. Enter the project name in Name field, browse for the location, and then click [OK] to leave.

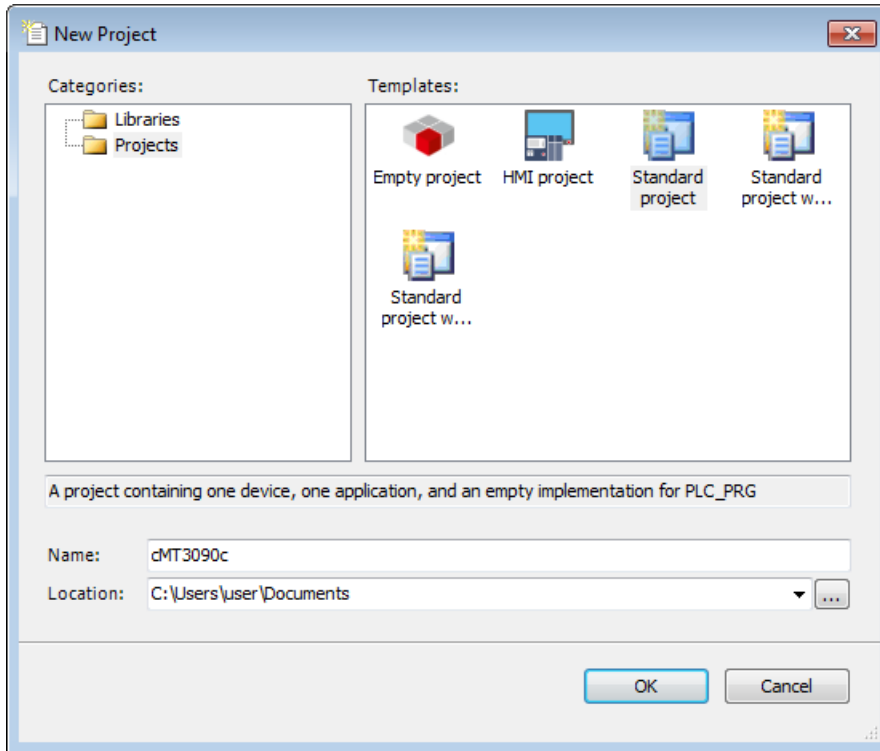

2. Select cMT-CTRL. CODESYS software provides 6 languages that can be selected in [PLC_PRG in:] drop-down list as shown below. Structure Text (ST) is used as an example in this manual.

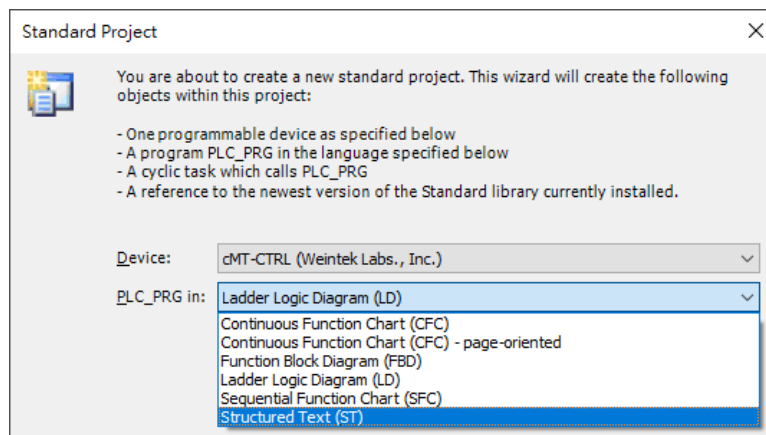

3. Double-click on Device (cMT-CTRL) to open the settings window.

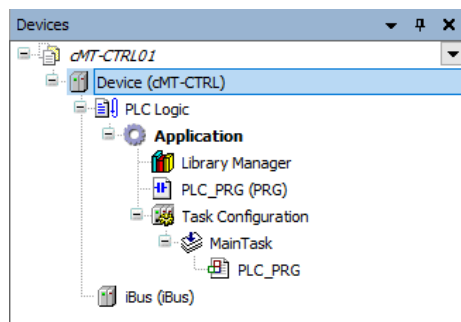

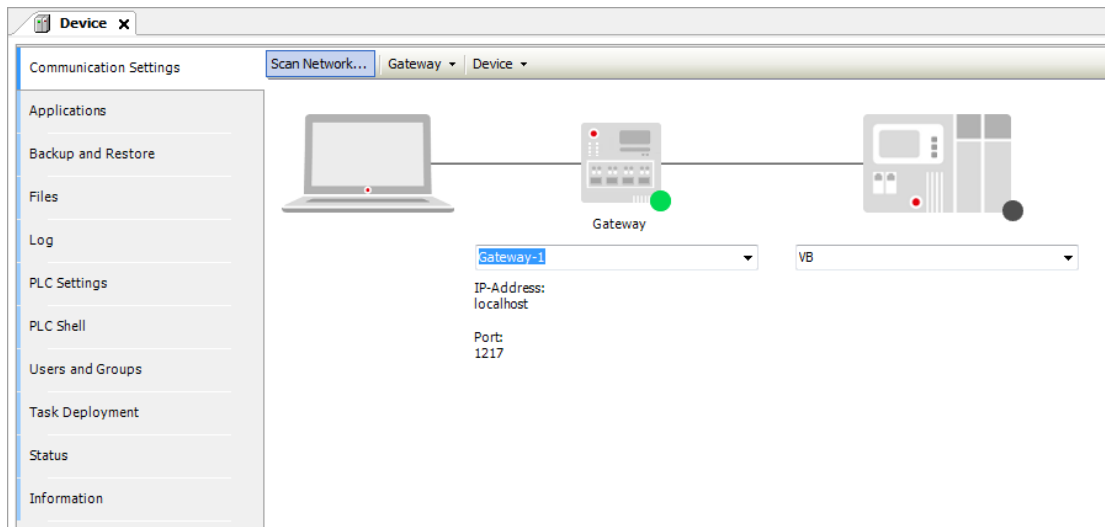

4. Open Scan Network tab, CODESYS software will start searching for the CODESYS devices on the same network. Select the desired device and then click [OK] to leave. The last two IP address parts (between dots) are converted into HEX digits and shown in this window. For example, if the IP address of the CODESYS device is 192.168.2.118, please select *HMI Name[0276]*. After clicking Wink button, CPU RUN LED flashes for three times.

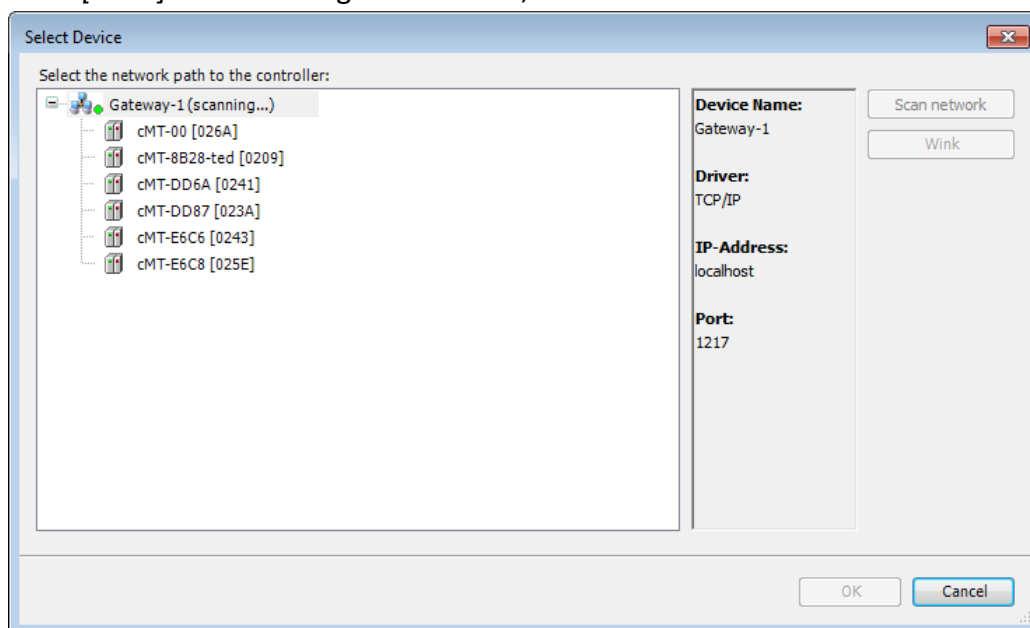

5. The project will connect the selected device.

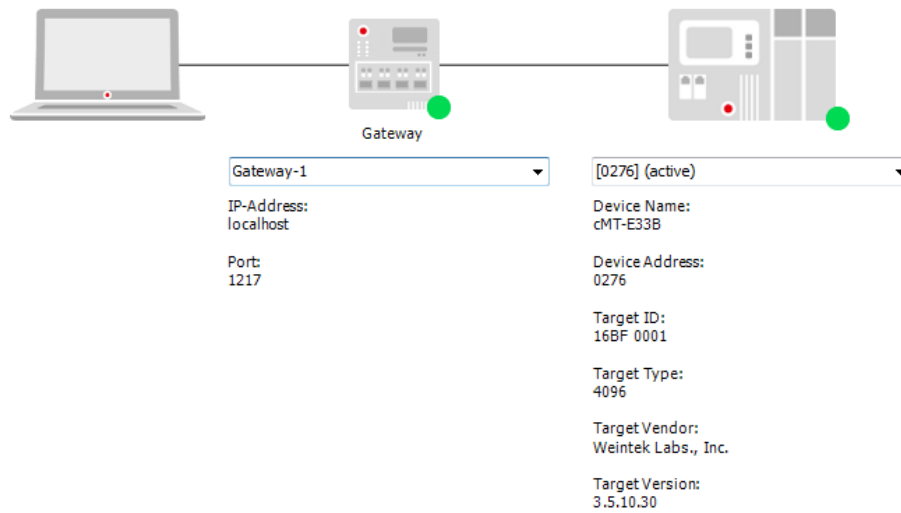

IP address of the device can be entered in the field shown below.

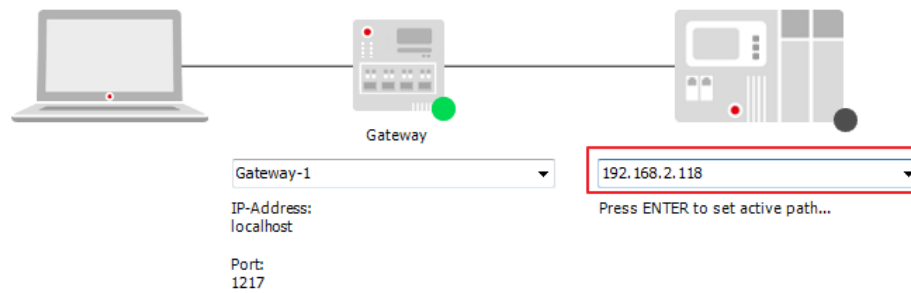

Chapter9. Creating EasyBuilder Project

*Please use EasyBuilder Pro v6.03.02 or later versions.

9.1. Creating Tags

1. Create several tags in PLC_PRG tab and make tag “test” accumulate automatically.

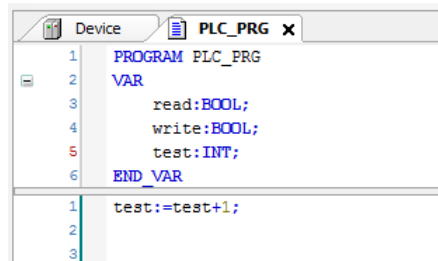

9.2. Exporting Tags

1. Right-click on Application in Devices tree and then select [Add Object] » [Symbol Configuration], use defaults.

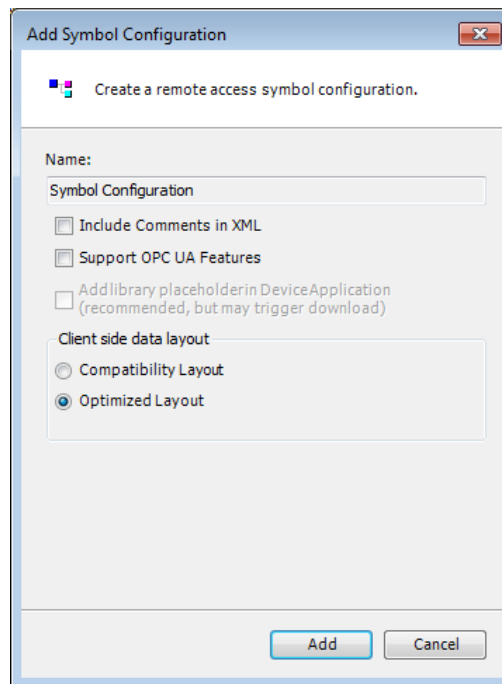

2. Find PLC_PRG, select the variables to be exported, and then click [Build].

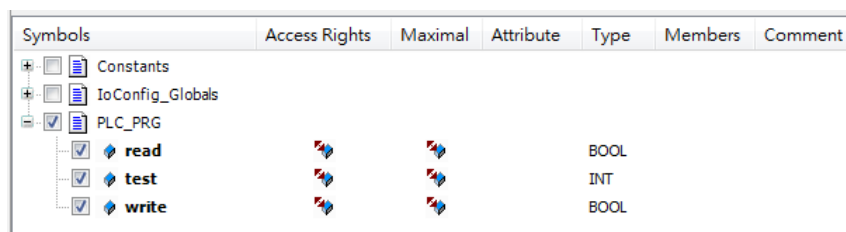

3. Select [Build] » [General code], the *.xml file can be found in the directory of the project.

9.3. Configuring EasyBuilder

Use Weintek Built-in CODESYS driver for cMT-CTRL01 Gateway, or use CODESYS V3 (Ethernet) driver for other HMI models to connect with CODESYS on cMT-CTRL01.

9.3.1. Connecting Built-in CODESYS

1. Create a project and select Weintek Built-in CODESYS in the device list.

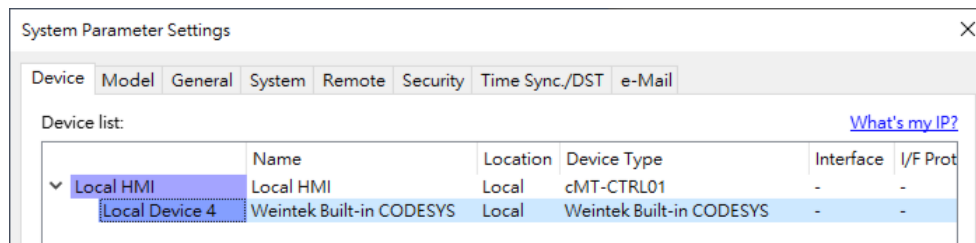

2. Click [Import Tag] to import the *.xml file built in preceding steps.

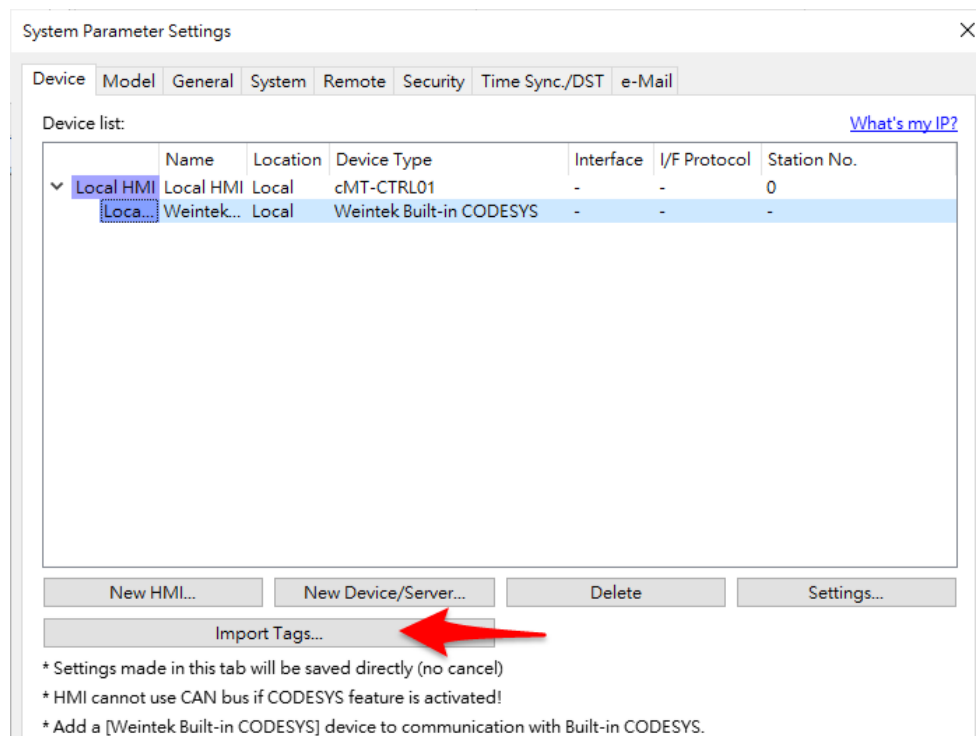

3. The CODESYS tags can now be found in Tag Manager.

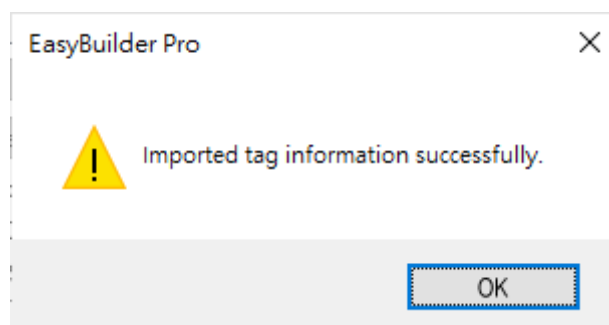

4. For cMT-CTRL01 Gateway, create OPA UA TAG, or use MQTT publisher. For other HMI models, create a Numeric object and use "Application.PLC_PRG.test" for address. After downloading the project to HMI, "test" tag data can be found.

9.3.2. Connecting cMT-CTRL01 CODESYS to other HMI

1. Create a project and select CODESYS V3 (Ethernet) driver in the device list.

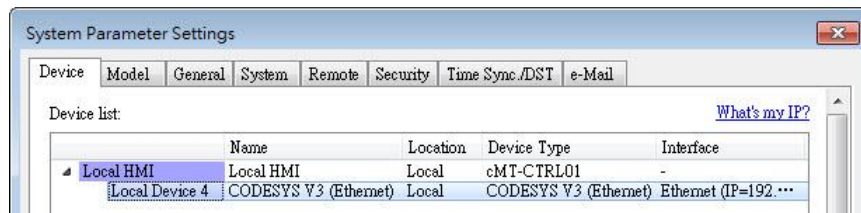

2. Click [Import Tag] and select the *.xml generated in the preceding steps.

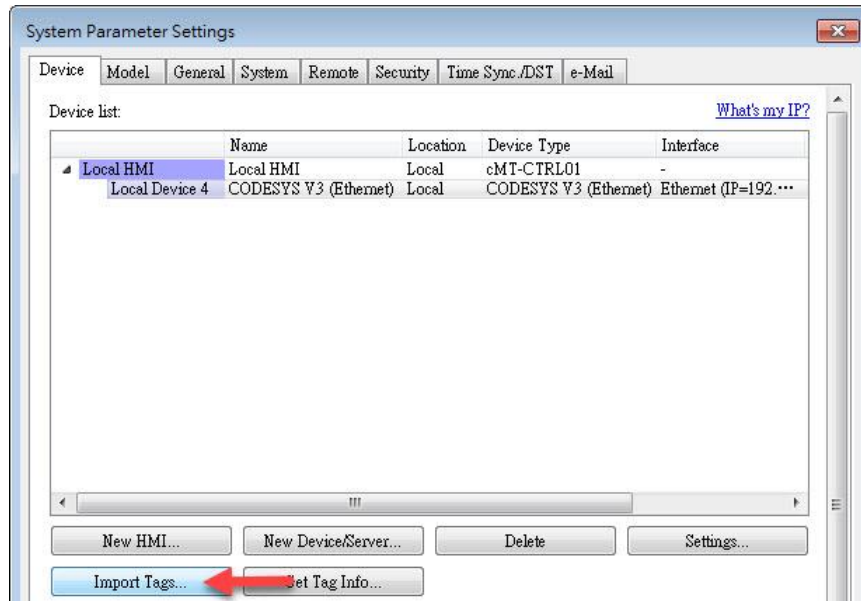

3. CODESYS Tag can be found after import.

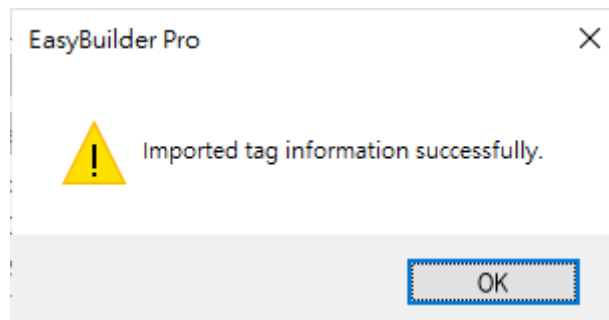

Chapter10. Connecting cMT-CTRL01 CODESYS to iR Series Modules

1. Right-click on [iBus (iBus)] and then select [Add Device].

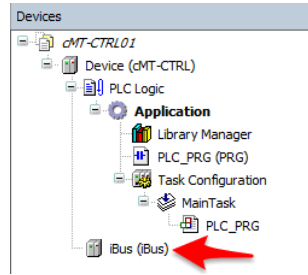

2. Select an iR module and then click [Add Device].

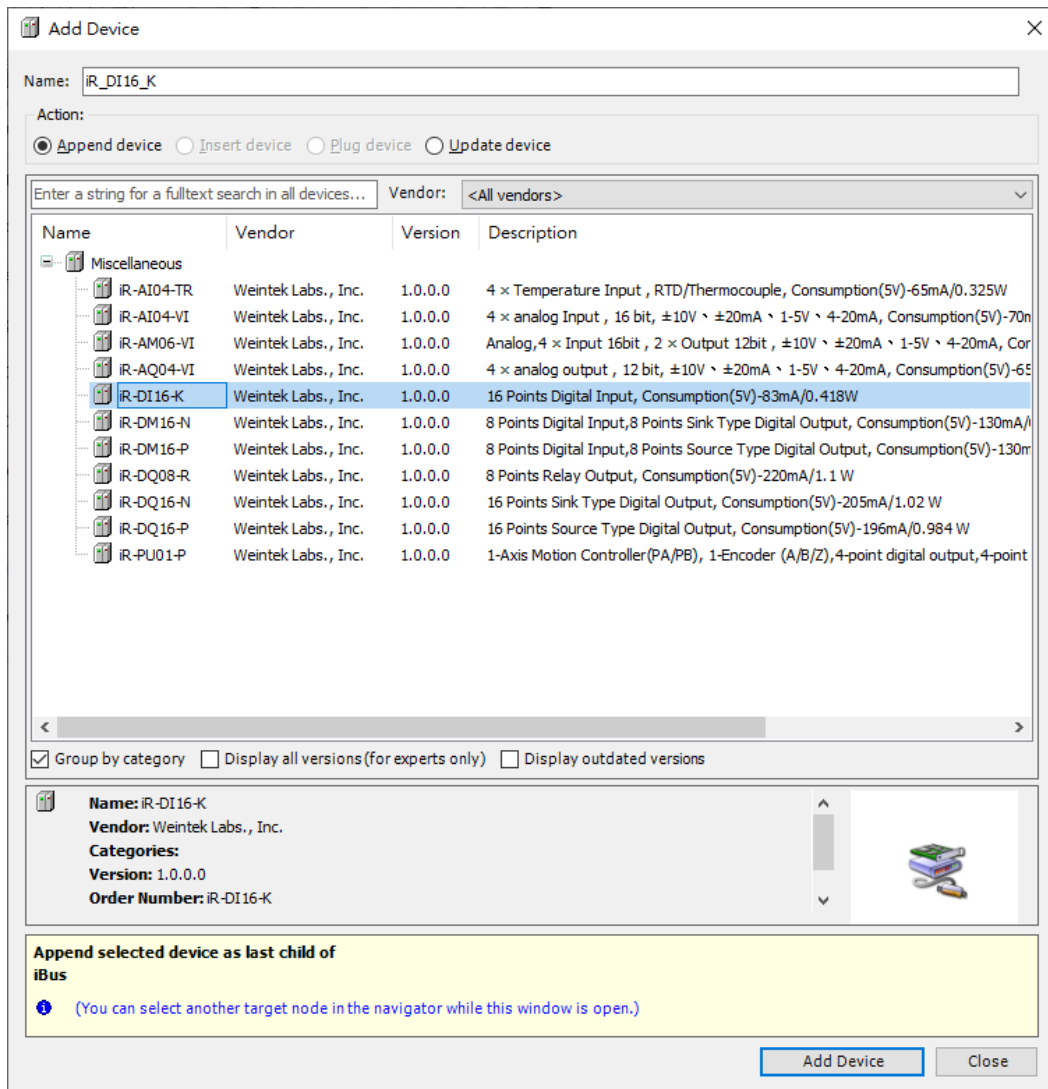

3. The added device can be found under iBus. You may add more modules with this window is left opened.

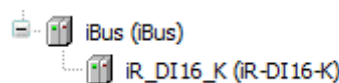

4. Double click on a module name to open iOption I/O Mapping.

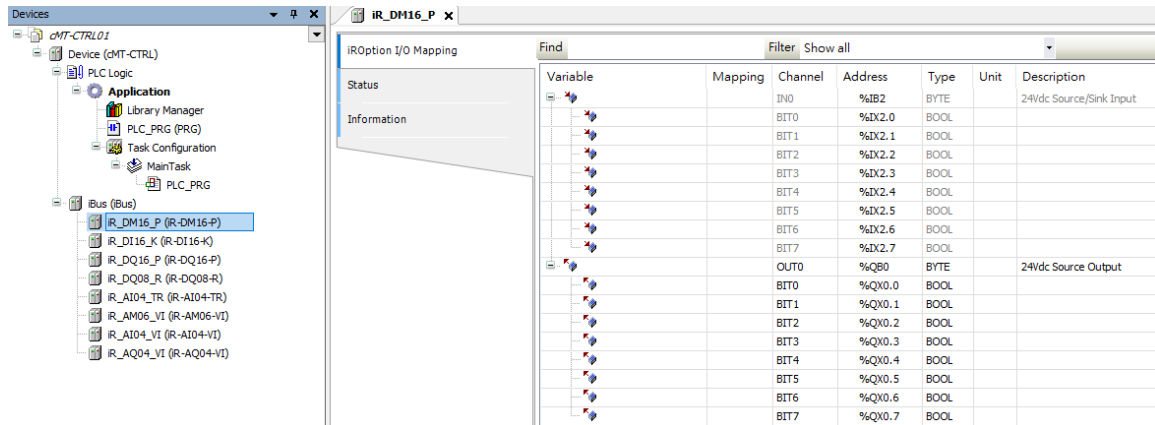

Analog modules, other modules, and their settings.

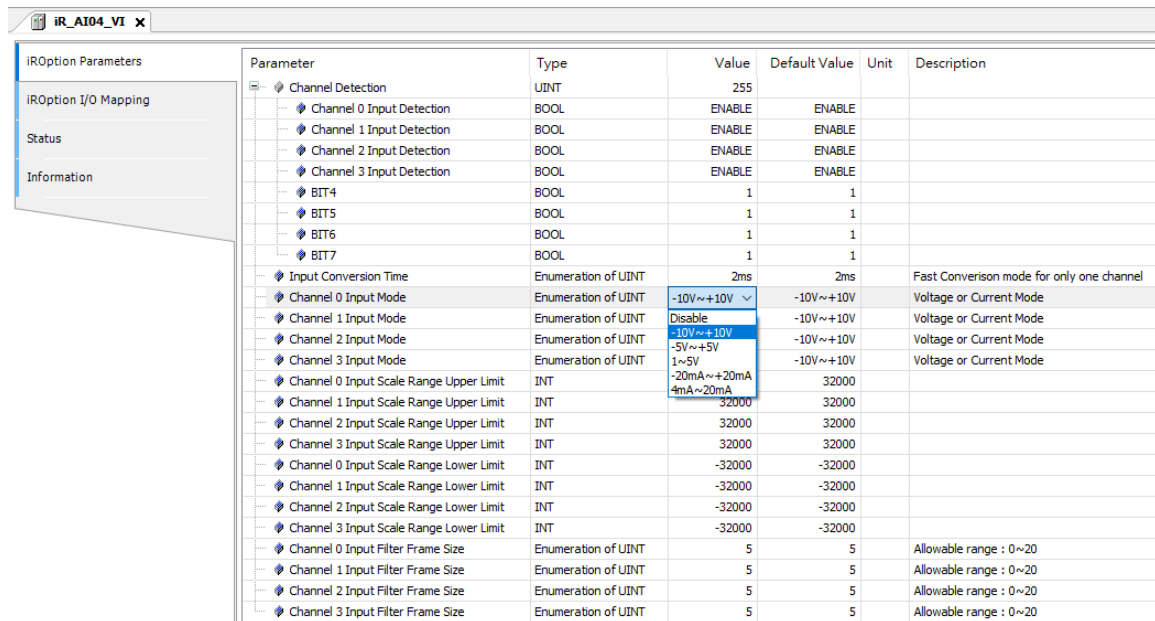

iBus has two addresses in BYTE type that show low voltage and I/O error.

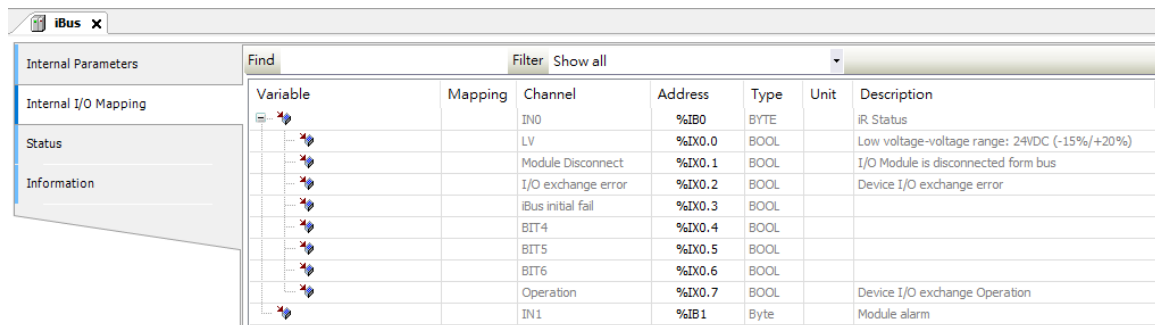

5. Open PLC_PRG in Devices tree and configure variables as shown below.

```

1  PROGRAM PLC_PRG
2  VAR
3      x0 : BOOL;
4      x1 : BOOL;
5
6  END_VAR
    
```

6. In Devices tree double click on an iR module name to open object settings window. In iROption I/O Mapping tab, select a variable for the object.

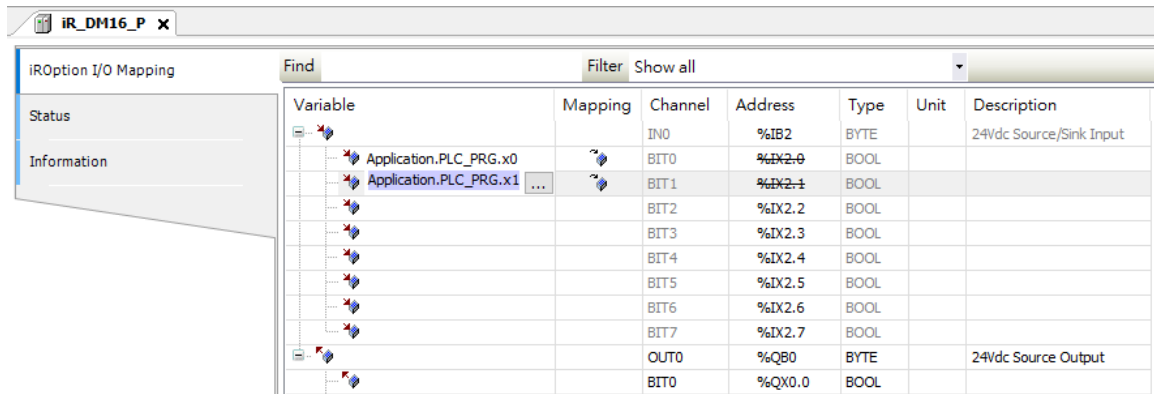

| Variable | Mapping | Channel | Address | Type | Unit | Description |
|------------------------|---------|---------|---------|------|------|-------------------------|
| | | IN0 | %IB2 | BYTE | | 24Vdc Source/Sink Input |
| Application.PLC_PRG.x0 | | BIT0 | %IX2.0 | BOOL | | |
| Application.PLC_PRG.x1 | | BIT1 | %IX2.1 | BOOL | | |
| | | BIT2 | %IX2.2 | BOOL | | |
| | | BIT3 | %IX2.3 | BOOL | | |
| | | BIT4 | %IX2.4 | BOOL | | |
| | | BIT5 | %IX2.5 | BOOL | | |
| | | BIT6 | %IX2.6 | BOOL | | |
| | | BIT7 | %IX2.7 | BOOL | | |
| | | OUT0 | %QB0 | BYTE | | 24Vdc Source Output |
| | | BIT0 | %QX0.0 | BOOL | | |

- When finished, click [Online] » [Login] to download the project to CODESYS.

Chapter 11. Connecting cMT-CTRL01 to iR-ETN

11.1. Connecting cMT-CTRL01 to iR-ETN using Modbus TCP/IP

1. Right-click on Device (cMT-CTRL01) and then select [Add Device].
2. Select [Ethernet Adapter] » [Ethernet] and then click [Add Device].

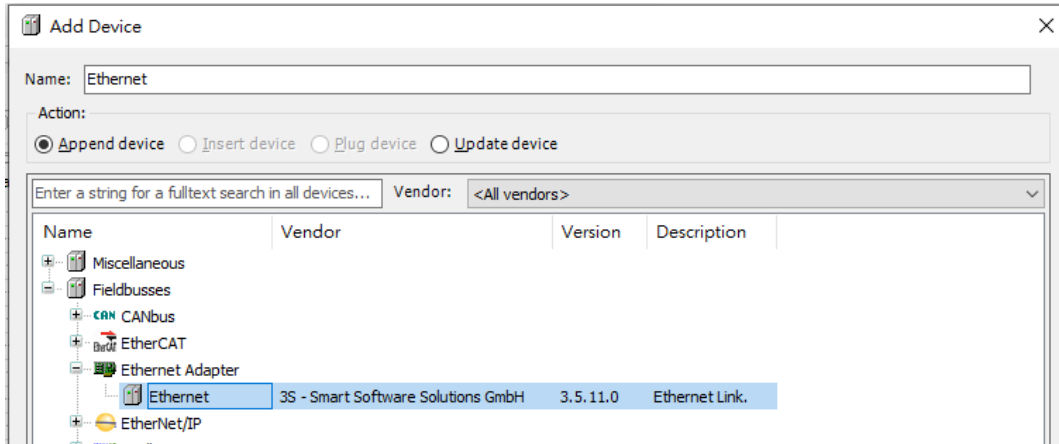

3. Ethernet (Ethernet) can be found in Devices tree.

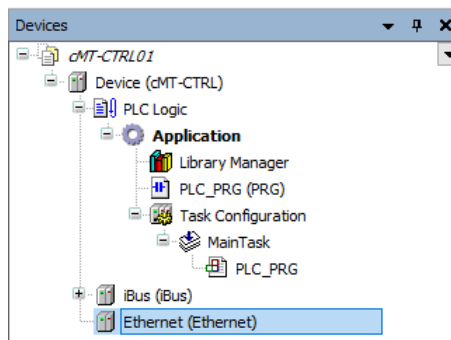

4. Double-click on Ethernet with the current window opened in Devices tree or right-click on Ethernet and then select [Add Device].
5. Click [Fieldbusses] » [Modbus] » [Modbus TCP Master] » [Modbus TCP Master], and then select [Add Device]. If you have the PLCopenXML exported from EasyRemotIO, click [Project] » [Import PLCopenXML...] to import the file to complete the settings.

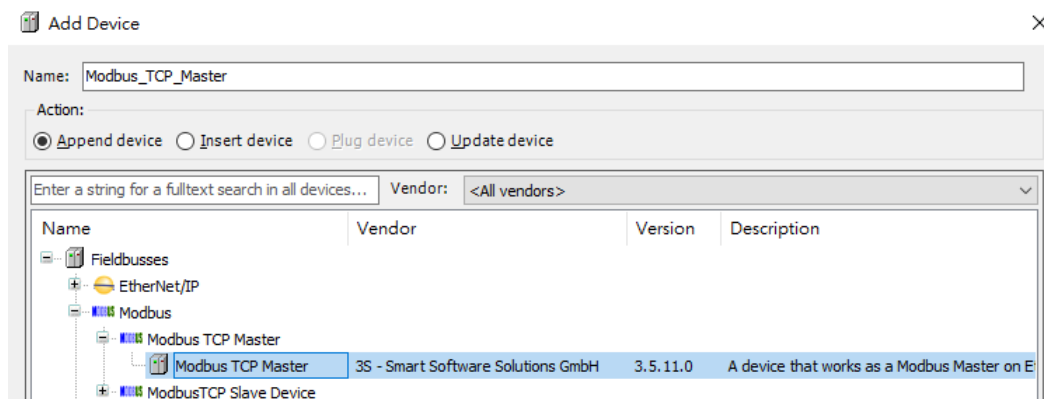

6. Double-click on Modbus TCP Master with the current window opened in Devices tree or right-click on Modbus TCP Master and then click [Add Device].

- Click [Fieldbusses] » [Modbus] » [Modbus TCP Slave] » [Modbus TCP Slave], and then select [Add Device].

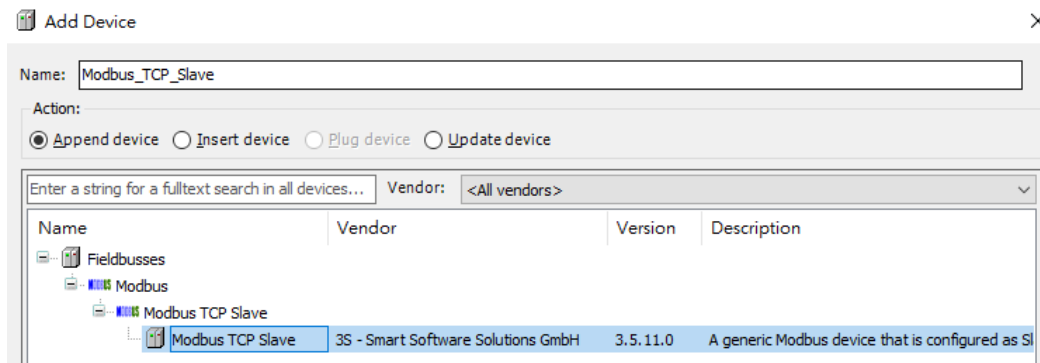

- Double click on Ethernet in the Devices tree, enter CODESYS's IP address in General tab, and then select [Change Operating System Settings]. When [Use operating System Settings] is selected, settings on cMT-CTRL01 will be used without being changed.

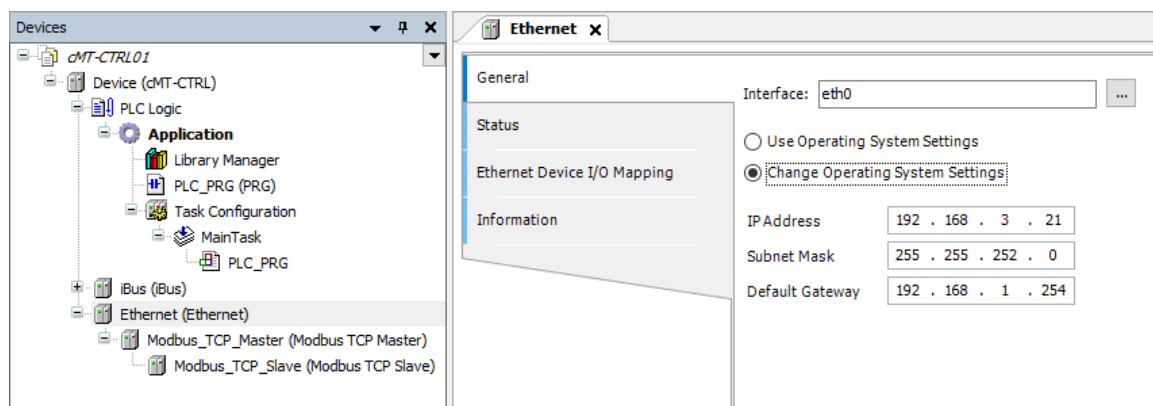

- When CODESYS is already connected, go to General tab and click the [...] button near Interface field and select eth0.

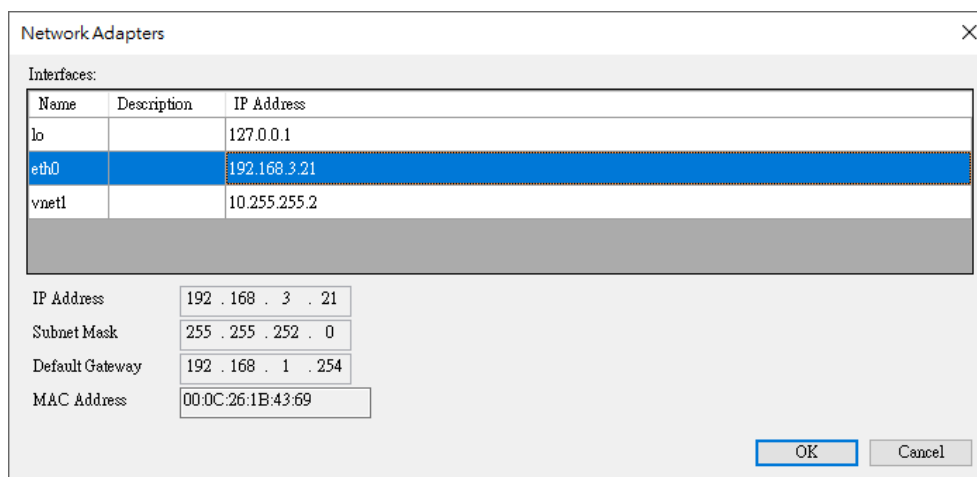

- Select Modbus_TCP_Slave in the Devices tree and then go to General tab to set up IR-ETN's IP address and Unit ID.

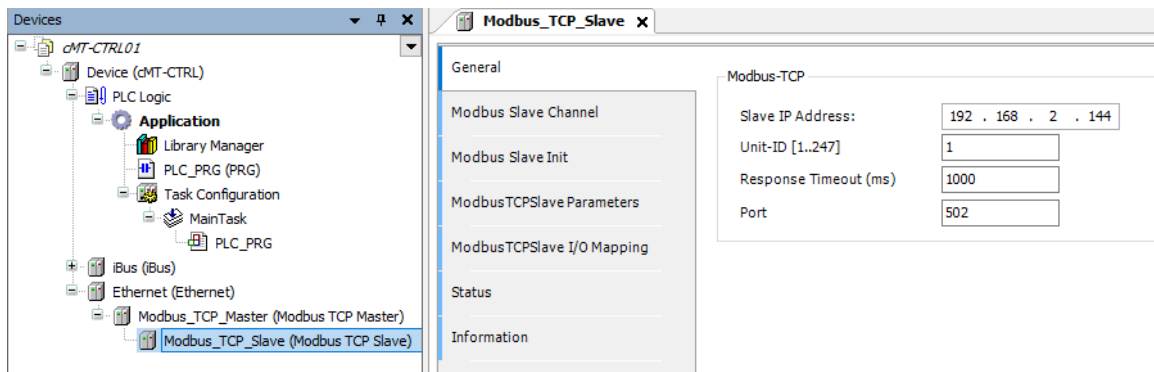

11. Open [Modbus Slave Channel] tab and create Modbus Variable.

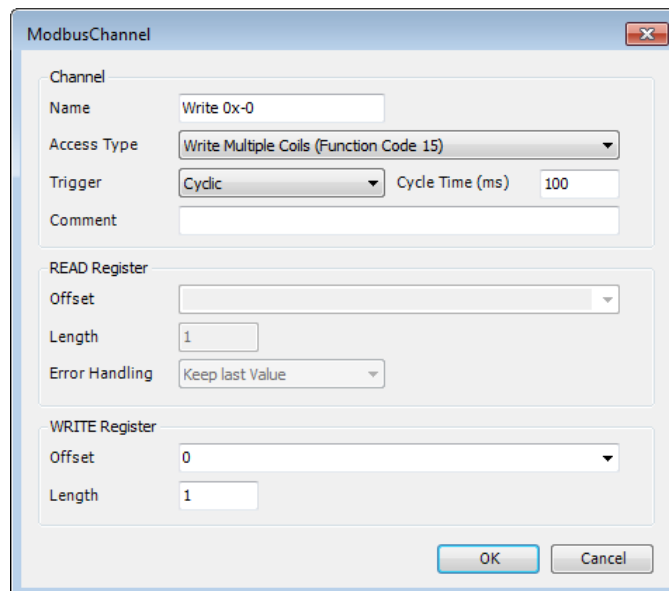
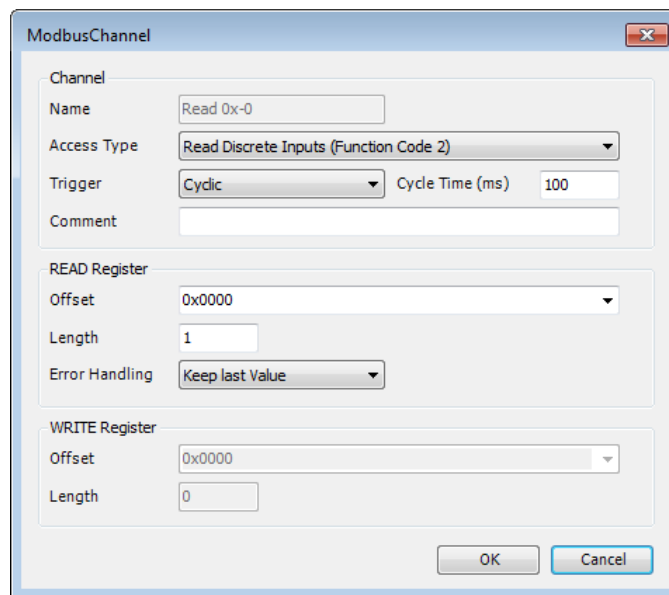

12. Open PLC_PRG in Devices tree, create tag and set Bool as data type. Write a command as shown below.

```

1 PROGRAM PLC_PRG
2 VAR
3     read:BOOL;
4     write:BOOL;
5 END_VAR
6
1 write:=1;
2

```

- Open Modbus_TCP_Slave in Devices tree and then go to [Modbus_TCPSlave I/O Mapping] tab to set up iR-ETN's IP address and Unit ID.

| Variable | Mapping | Channel | Address | Type | Unit | Description |
|---------------------------|---------|---------------|---------|----------------------|--------|----------------------|
| | | Read 0x-0 | %IB0 | ARRAY [0..0] OF BYTE | | Read Discrete Inputs |
| | | Read 0x-0[0] | %IB0 | BYTE | | Read Discrete Inputs |
| Application.PLC_PRG.read | | Bit0 | %IX0-0 | BOOL | 0x0000 | 0x0000 |
| | | Write 0x-0 | %QB0 | ARRAY [0..0] OF BYTE | | Write Multiple Coils |
| | | Write 0x-0[0] | %QB0 | BYTE | | Write Multiple Coils |
| Application.PLC_PRG.write | | Bit0 | %QX0-0 | BOOL | 0x0000 | 0x0000 |

- When finished, click [Online] » [Login] to download the project to CODESYS.

11.2. Connecting CODESYS and Modbus TCP/IP Gateway

cMT-CTRL01 supports Modbus TCP/IP Gateway which allows CODESYS to access Modbus TCP/IP Gateway using Modbus TCP Slave, in order to control the devices connected to Modbus TCP/IP Gateway.

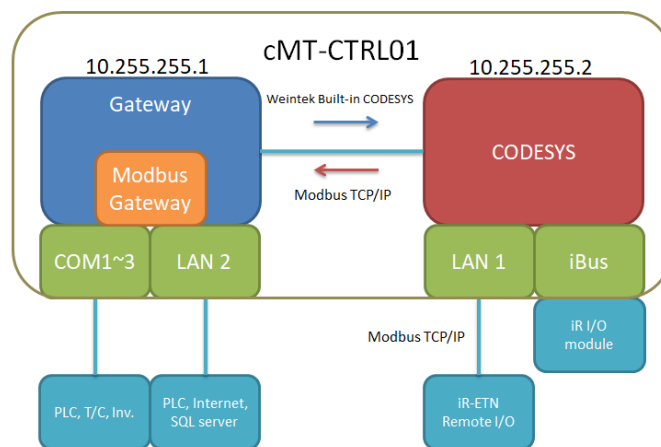

11.2.1. CODESYS Settings

On cMT-CTRL01, Gateway and CODESYS respectively use different IP addresses; therefore, by adding Modbus_TCP_Slave for CODESYS and set IP address to 10.255.255.1, CODESYS is able to connect to Modbus Gateway.

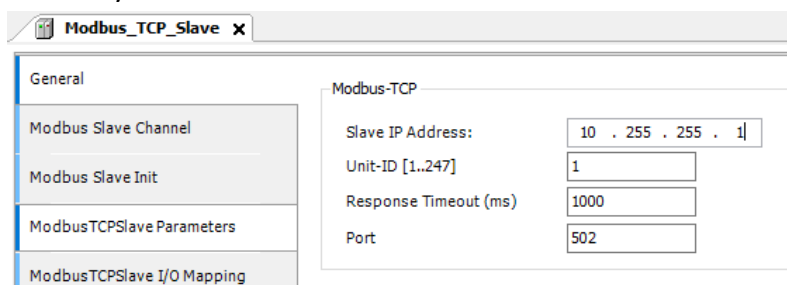

To immediately display CODESYS data on HMI, values can be written to HMI's LW registers for objects to read. When setting Modbus Slave Channel, Cycle Time can be configured to adjust the frequency at which data is written to the registers.

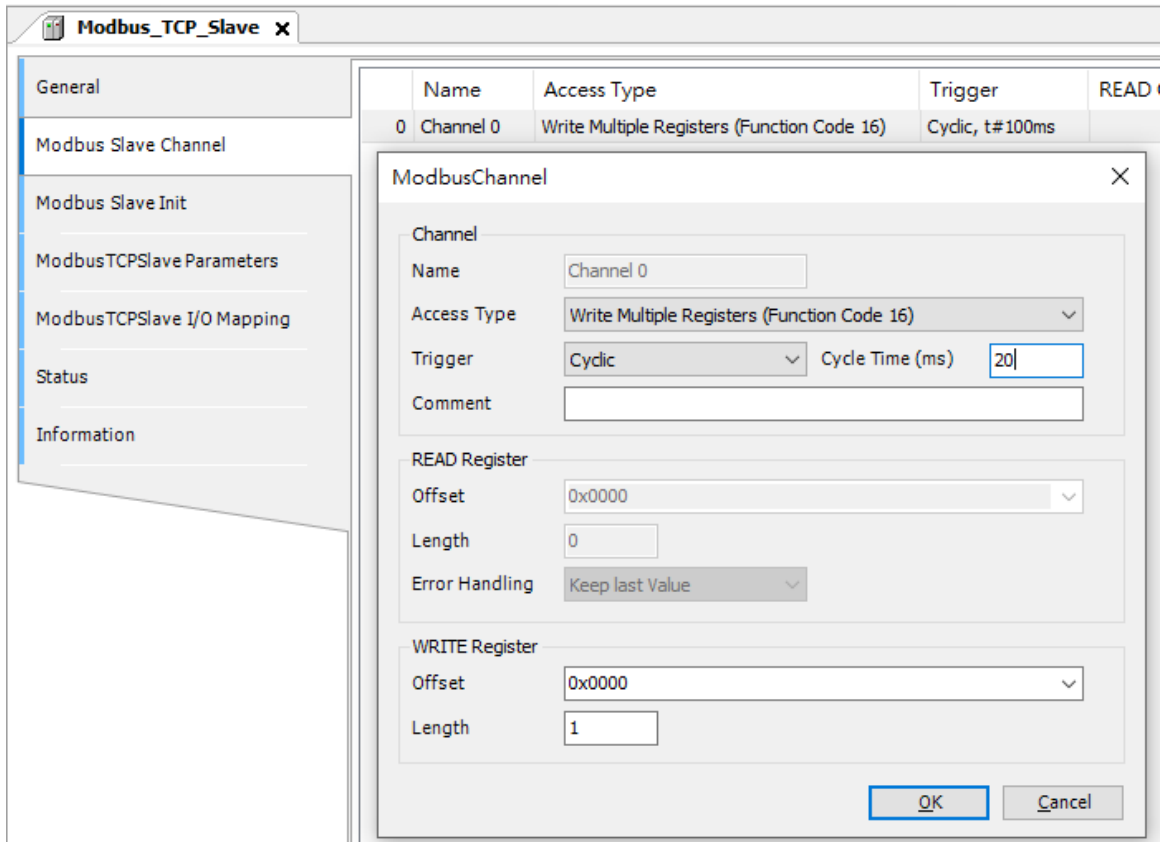

11.2.2. Gateway Settings

For more information on Modbus Gateway, please see EasyBuilder Pro User Manual [Chapter 37. MODBUS TCP IP Gateway](#).

Chapter 12. Connecting cMT-CTRL01 via EtherCAT

From CODESYS Firmware 20200401, cMT-CTRL01 supports EtherCAT connection. Please see Chapter 14.2 Questions relating to Downloading cMT CODESYS File, and Chapter 7 Installing Weintek CODESYS and RemoteIO Package in this manual for more information.

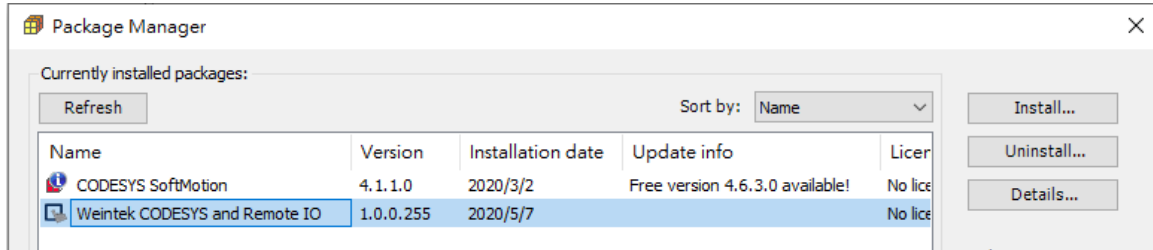

This chapter explains how to connect cMT-CTRL01's LAN1 to iR-ECAT and iR module.

Open the CODESYS project file of cMT-CTRL01 and add a device. The recommended device is EtehrCAT Master V3.5.12.0. This device can be found when [Disaply all versions (for expert only)] is selected.

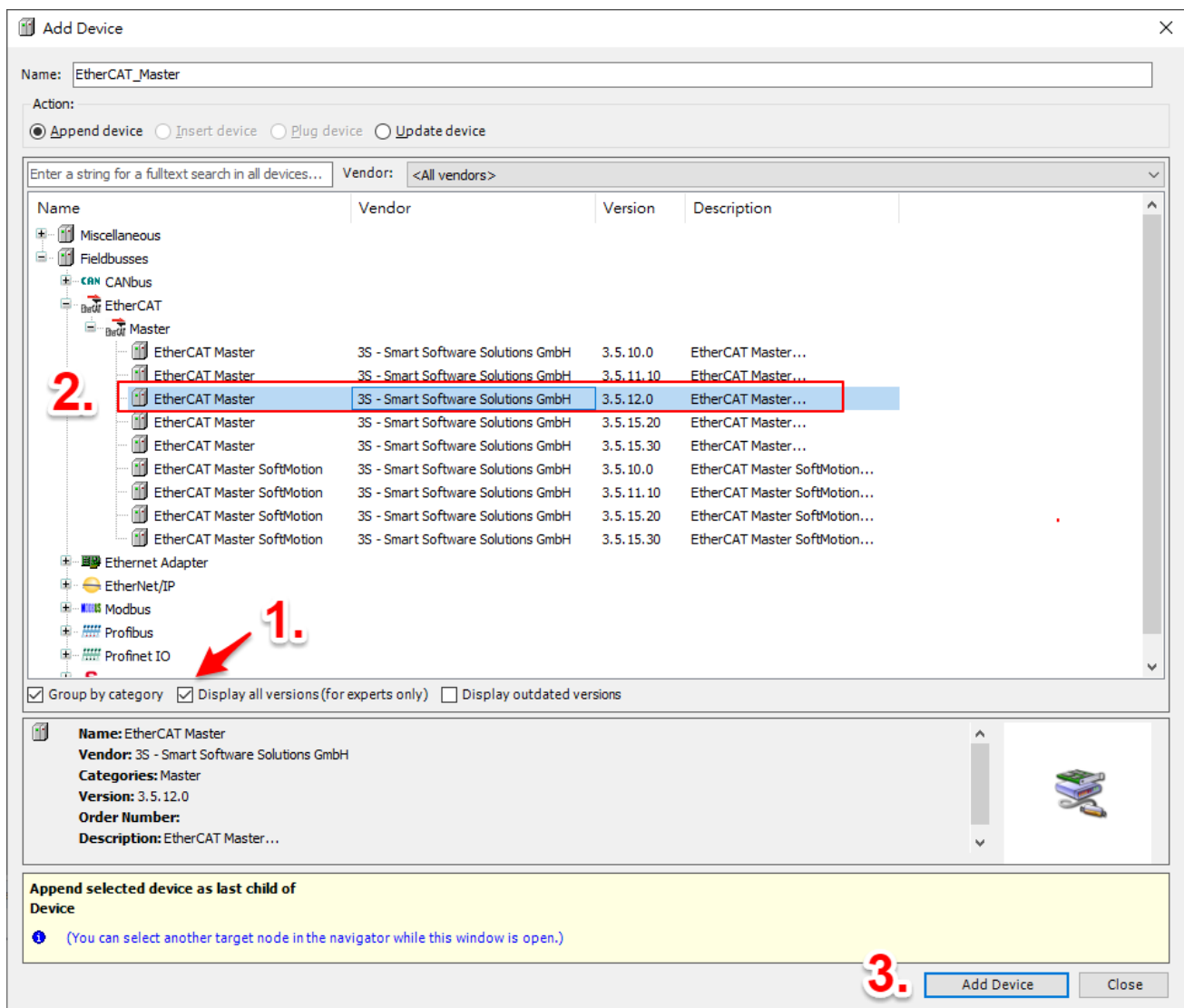

After adding the device, select cMT-CTRL01. Double click on EtherCAT Master, click [Browse...], and select network adapter eth0.

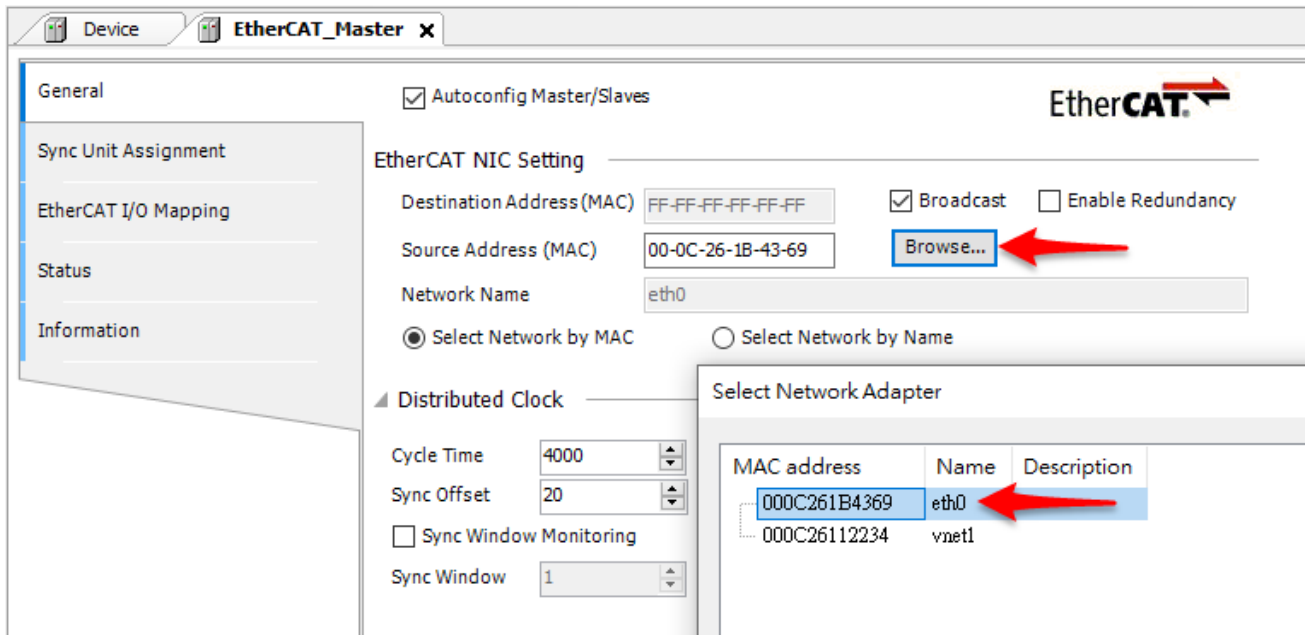

To set the device manually, add iR-ECAT first. iR-ECAT may have multiple versions, please select a suitable version.

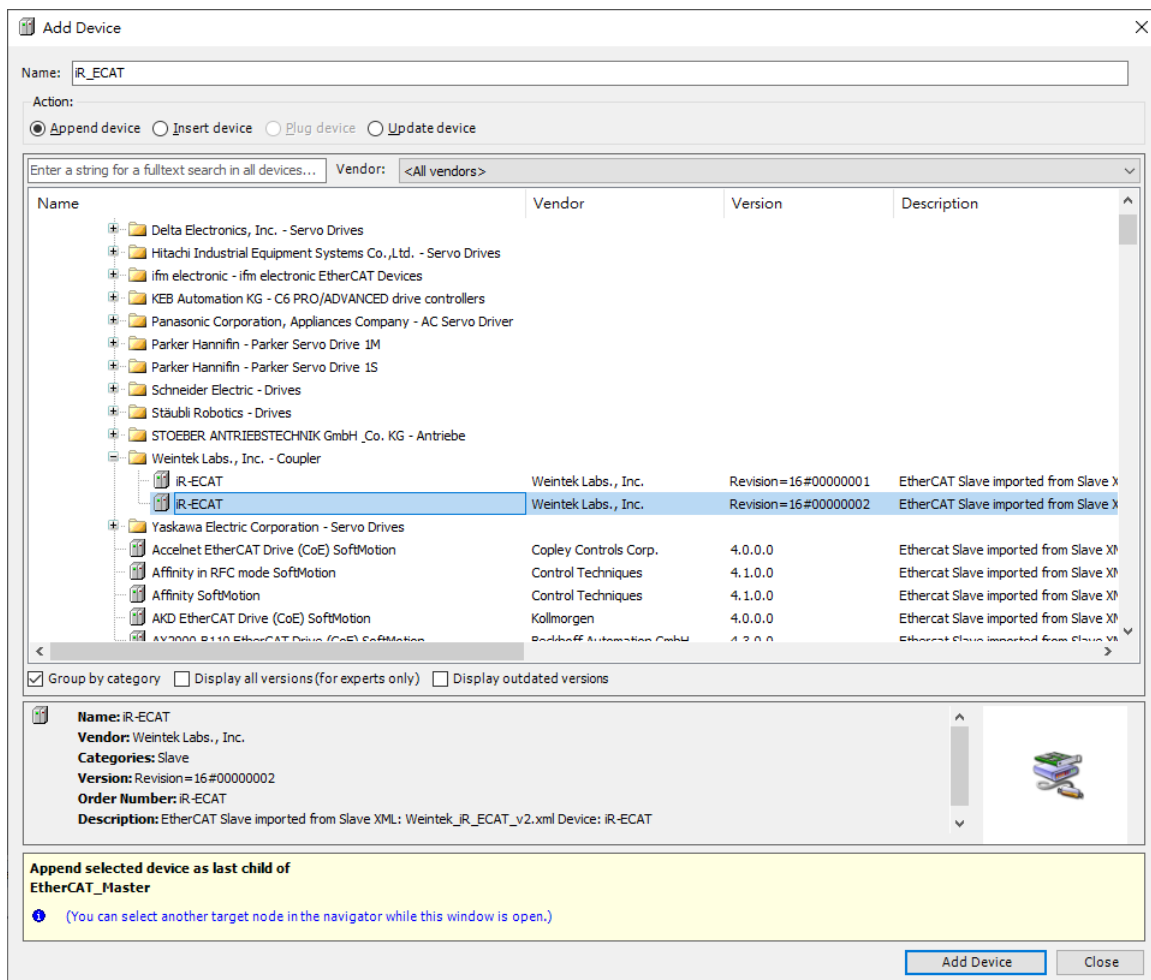

Add iR I/O module.

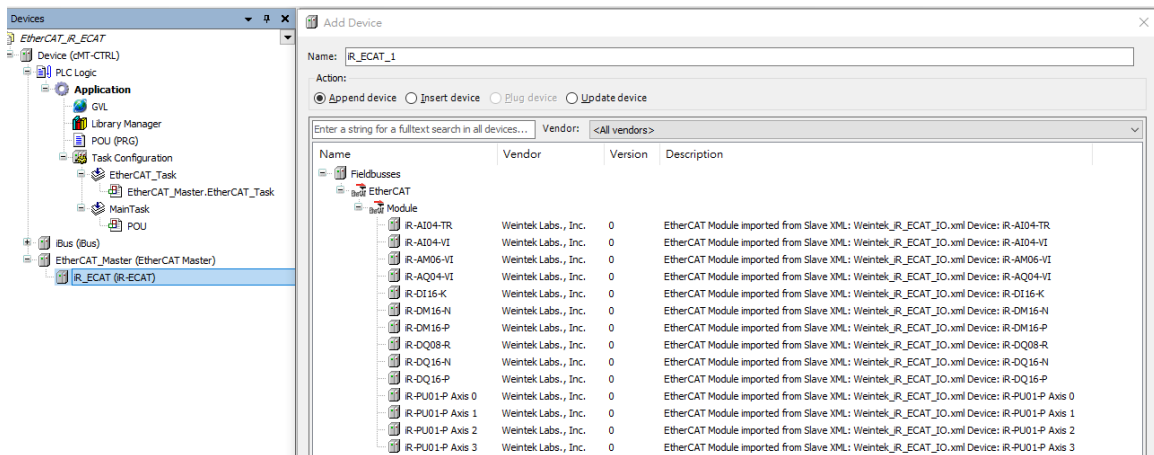

CODESYS can scan EtherCAT devices on the network. Set the device and select cMT-CTRL01. Right-click on EtherCAT Master and then select [Scan For Devices...].

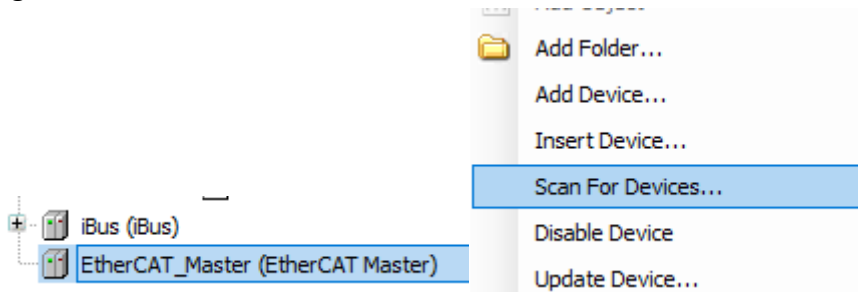

Information on iR-ECAT and iR I/O modules is displayed in the Scan Devices window. Click [Copy All Devices to Project] to finish setting up the device.

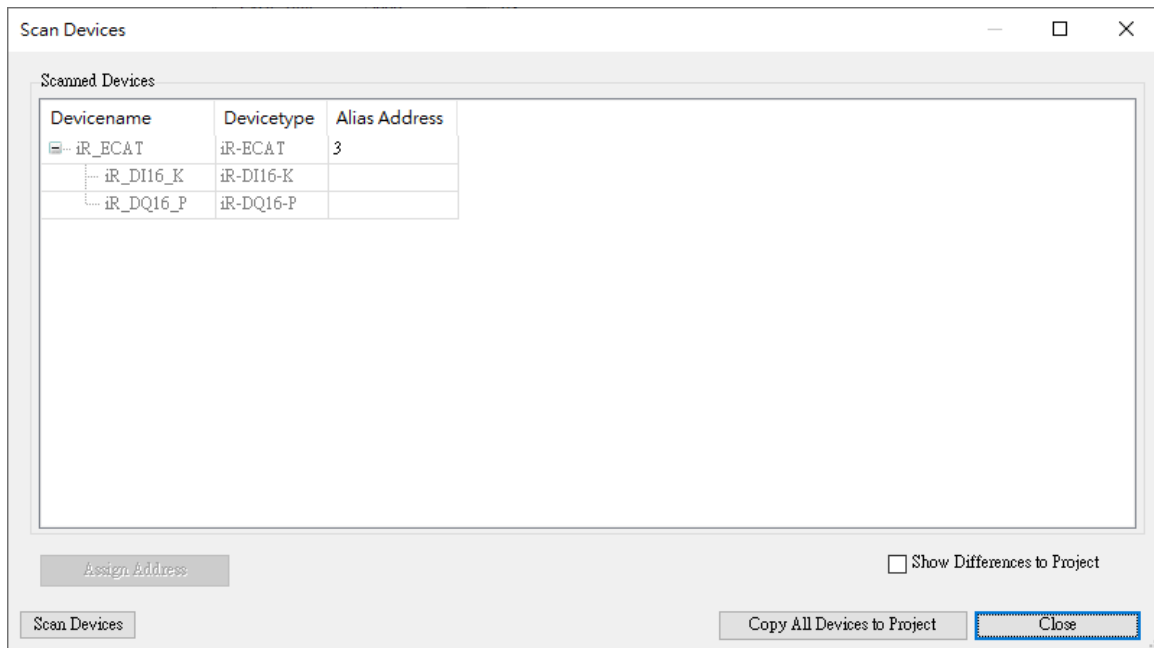

Chapter13. Removing Weintek Built-in CODESYS

1. Click [Tools] » [Packages Manager].
2. Find Weintek Built-in CODESYS and then click [Uninstall].

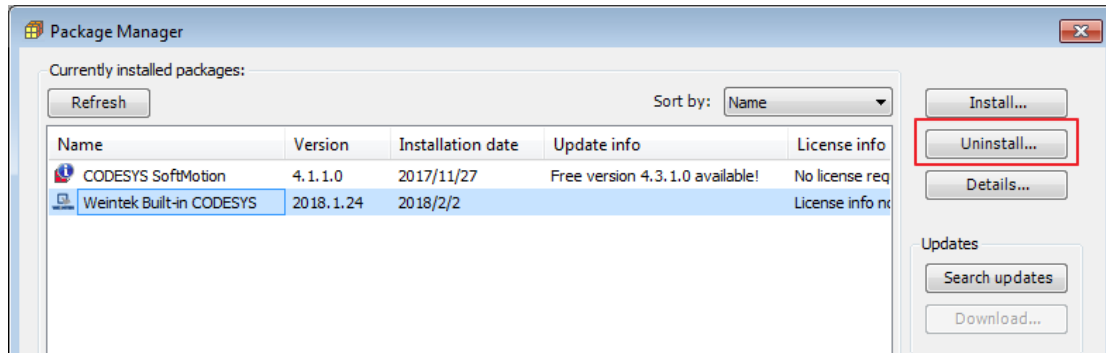

3. Click [Next] when seeing the window below.

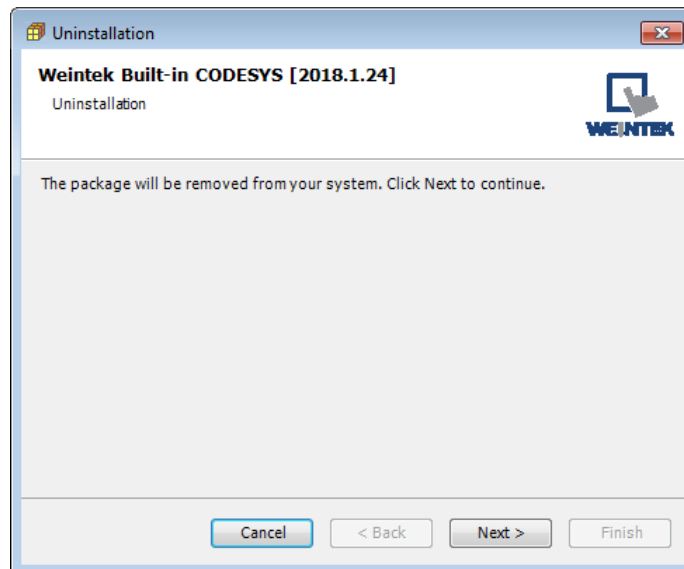

4. Removing the program.

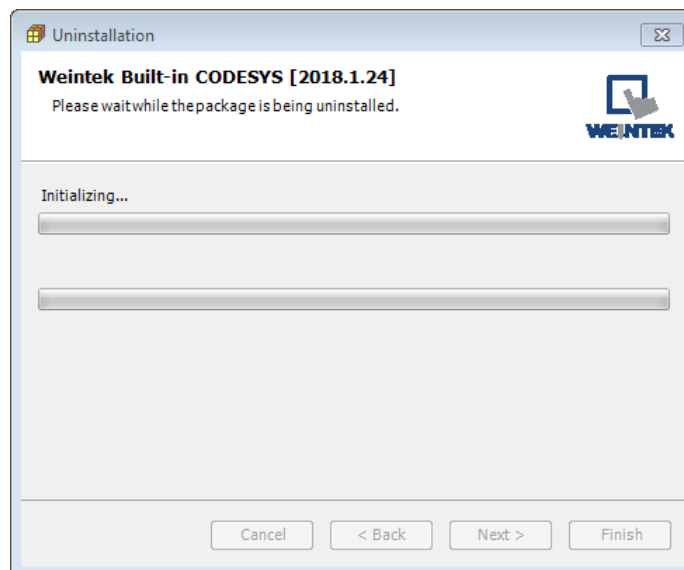

5. Click [Finish].

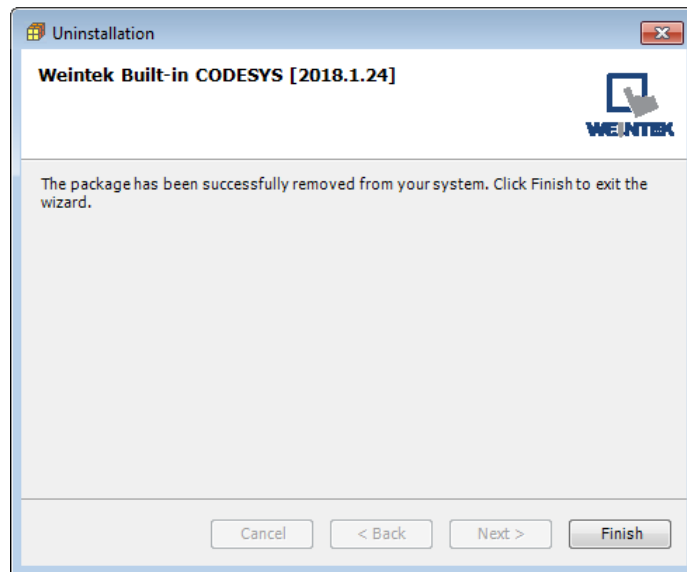

Chapter14. Frequently Asked Questions

14.1. Questions Related to CODESYS

Q1. When the indicator of CODESYS Gateway lights up in red, how can I connect to the device?

A: When CODESYS Gateway is not properly started or installed, its indicator will light up in red.

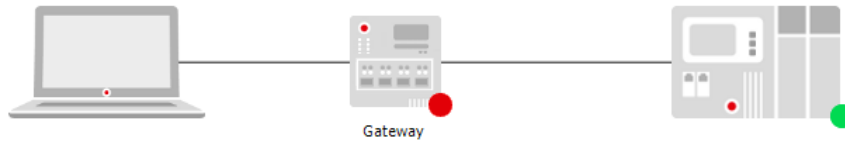

Please try the following 3 methods to solve this situation.

1. Click the icon of “CODESYS Gateway SysTray” in system settings and then click [Start Gateway].
2. Add new gateway and enter HMI IP.

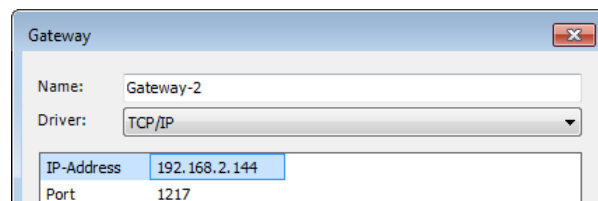
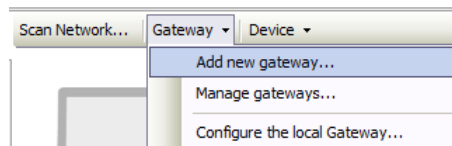

3. Re-install CODESYS Gateway.

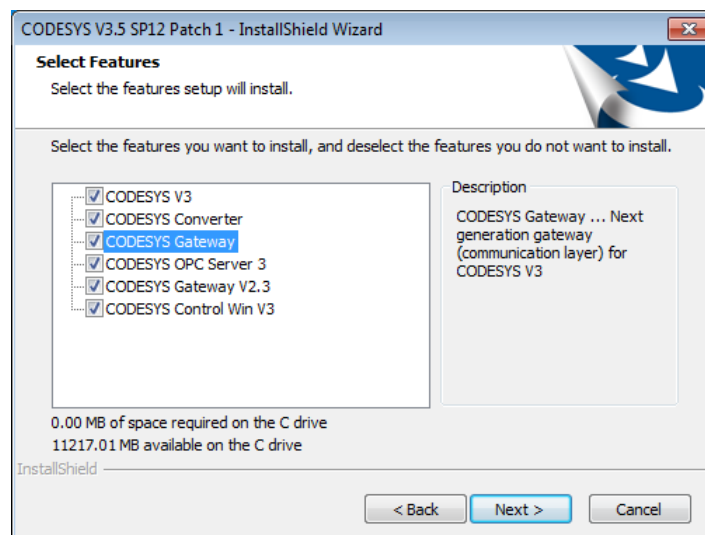

Q2. Why a triangle icon shows near Modbus_TCP_Slave device when I log in HMI in CODESYS software?

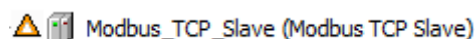

A: This means that HMI cannot connect Modbus TCP/IP device via CODESYS. Please check the

IP settings and make sure the cable is properly connected.

Q3. Which CODESYS Development System version is suitable for cMT+CODESYS? Is there any other version to use?

A: Use the same version as cMT+CODESYS runtime

The built-in CODESYS Runtime of cMT+CODESYS is 3.5.10.30; therefore, using CODESYS Development 3.5.10.30 is recommended.

Download link: <https://www.weintek.com/globalw/Download/Download.aspx>

Use a later version on PC

Versions later than CODESYS Development 3.5.10.30, including 64bit versions are also compatible. The CODESYS Library offered by Weintek can work properly when using these versions.

The current latest version of CODESYS Development is 3.5.15.20 (Date: 19/11/2019)

Download link:

<https://store.codesys.com/codesys.html#All%20versions>

Please note that Missing Libraries issue may occur when using a new version CODESYS Development System to open an earlier version CODESYS project.

The following two solutions can be used to address this issue:

1. Click "Download Missing Libraries" in Library Manger.
2. Use cMT+CODESYS Package (PC) 1.0.0.229 or later (1.0.0.229 is not included), select and install library version 3.5.10.30.

Upgrade from CODESYS V2.3 to CODESYS V3.5

CODESYS offers a tool for users to use CODESYS Development 2.3 project in CODESYS V3.5 Development. Reference link:

<https://store.codesys.com/codesys-v23-converter.html>

Use compatible version for EasyRemoteIO to work with CODESYS

By default, the PLCopen XML file exported from EasyRemoteIO can work in CODESYS Development System V3.5.10.0. The following two ways are options for using other versions.

1. Set the version in EasyRemoteIO before exporting PLCopen XML. (supported by EasyRemoteIO V1.3.1.0 or later)
2. Open PLCopen XML file in Windows® Notepad software, change the <Version> to the current version of CODESYS Development, and save to a new file. Let's take CODESYS Development version 3.5.12.0 as an example:

In Notepad, change from `<Version>3.5.10.0</Version>`

to `<Version>3.5.12.0</Version>`.

14.2. Questions Related to Downloading cMT CODESYS File

Q1. How to update CODESYS firmware?

A:

There are 2 ways to update CODESYS firmware.

1. Launch Utility Manager and select Gateway Series » Maintenance » CODESYS Firmware Update. Browse for the firmware file and click [Update].

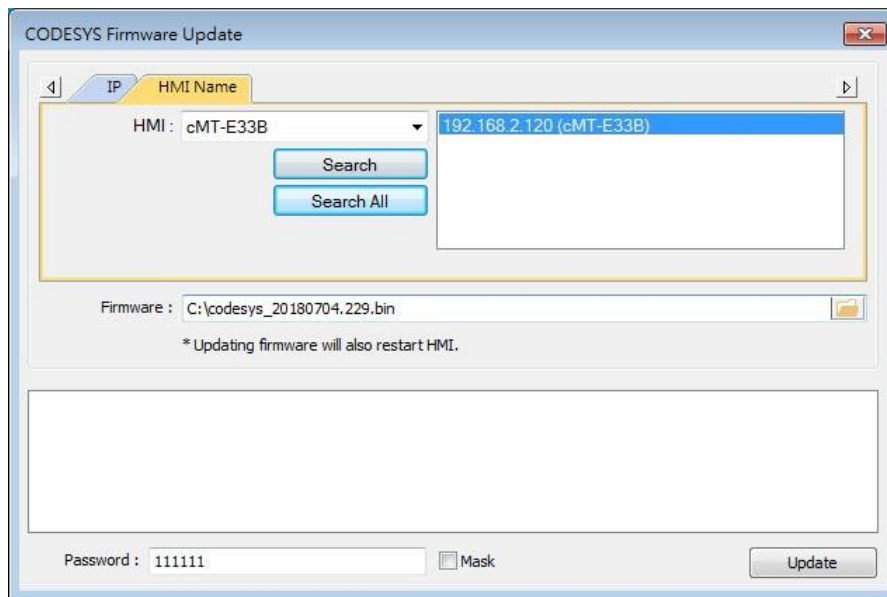

2. Enter cMT HMI's IP address in the website browser and find [CODESYS] » [CODESYS update] tab. Select the file and click [Update].

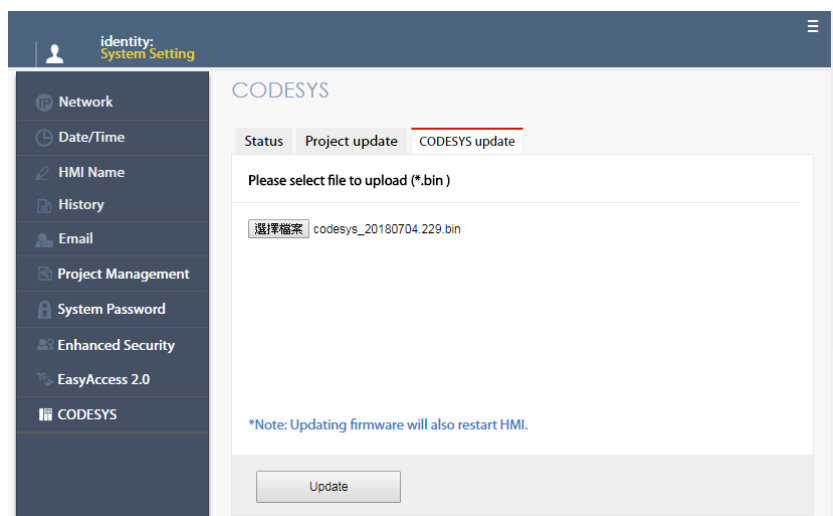

Q2. How to download CODESYS project using website?

A:

1. In CODESYS software select [Online] » [Create boot application]. An *.app file and a *.crc file will be generated.

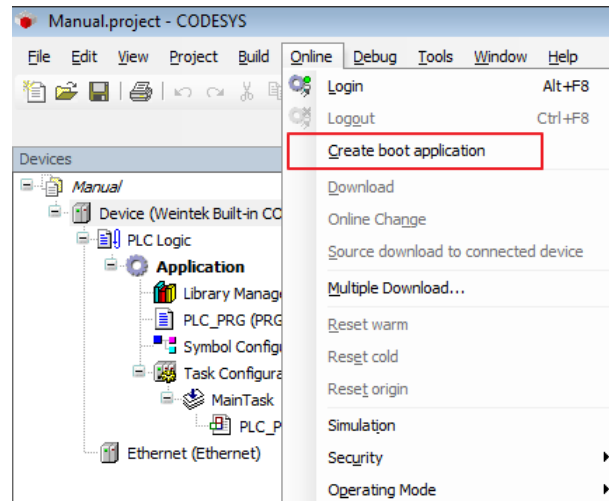

2. Enter cMT HMI's IP address in the website browser and find [CODESYS] » [Project update] tab. Select the files generated in the previous step and click [Update].

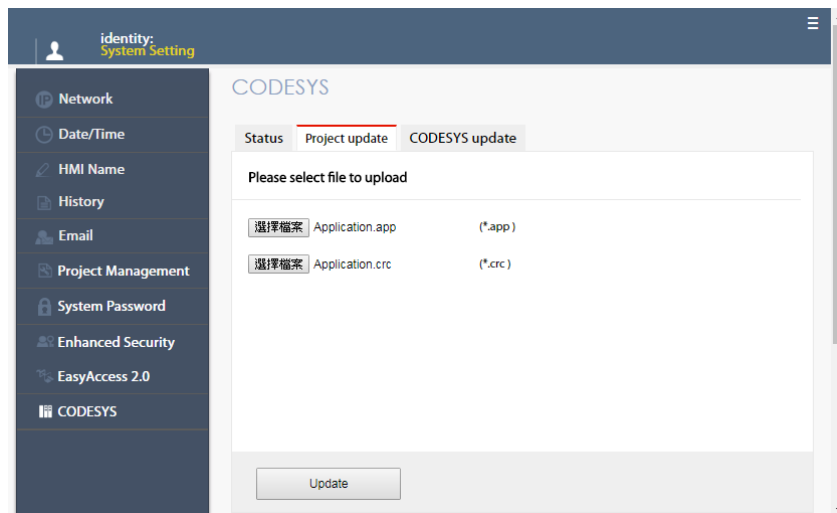

CODESYS® is a trademark of 3S-Smart Software Solutions GmbH.

Windows is a trademark or a registered trademark of Microsoft Corporation in the United States and/or other countries.

Other company names, product names, or trademarks in this document are the trademarks or registered trademarks of their respective companies.

This document is subject to change without prior notice.

Copyright© 2019 Weintek Lab., Inc. All rights reserved.