

IPM-104

Pictures:

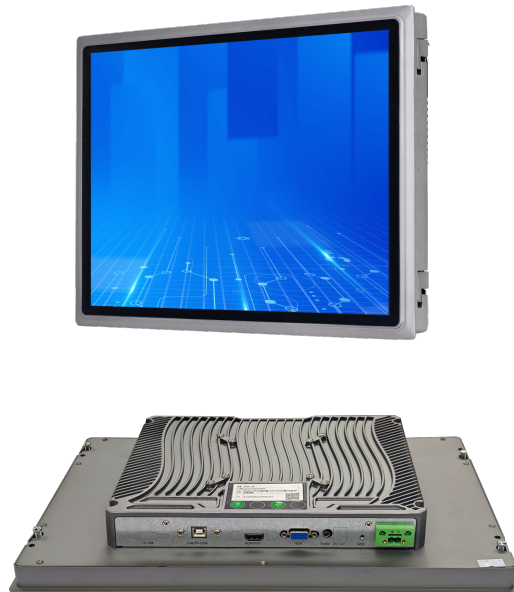

Technical Drawings

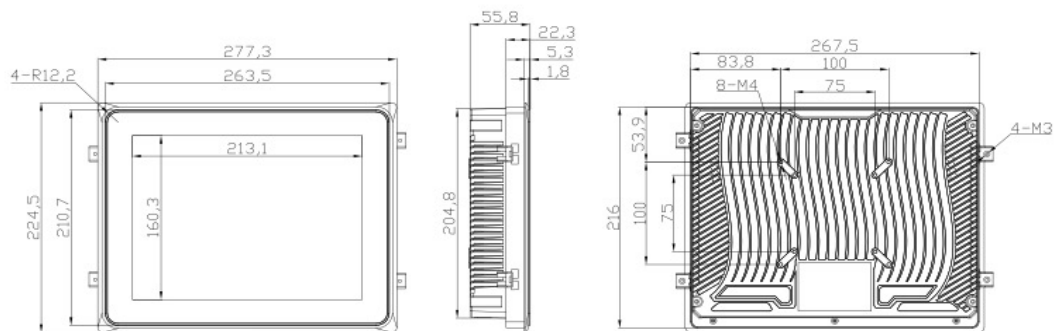

Features:

- 10.4" Touchscreen Display
- Full Flat, IP65 Waterproof Front Panel
- 1x HDMI, 1x VGA
- VESA Mountable
- Rugged Die-cast Aluminum
- DC 12V (3A)
- Color: Silver

Specifications:

Display Feature	Display Screen	10.4" LCD
	Size Ratio	4:3
	Resolution	1024x768
	Brightness	500cd/m ²
	Contrast ratio	900:1
	Touch Screen	Resistive touch screen
Power	Power Supply	DC 12V (3A)
I/O Interface	USB	1x USB (For touch screen cable)
	HDMI	1x HDMI
	VGA	1x VGA
Environmental	Operating Temperature	-10 ~ +60°C
	Storage Temperature	-20 ~ +60°C
	Storage Humidity *Non-condensing	5 ~ 95%
Mechanical	Dimensions	277.3mm (L) * 224.5mm (W) * 55.8mm (H)
	Material	Rugged Die-cast Aluminum
	Weight	2.75kg / 4.25kg (NET./GROSS.)
	Color	Leadon