

User Manual

M02 Startup Guide

Table of Contents

Chapter 1 Overview	1
1.1 Specification	1
1.2 Dimensions	2
1.3 Installation	3
Chapter 2 Wi-Fi Settings	4
2.1 Set in internet browser	4
2.2 Set on HMI	6

Chapter 1 Overview

1.1 Specification



WiFi Expansion Module

Feature

- Modular design, adds wireless connectivity to HMI.
- WiFi standards supported include: IEEE 802.11b/g/n.
- Compact design and little protrusion when installed on HMI, which avoid space issue in control cabinet installation.
- The magnetic mount antenna included in the package can be installed at an optimal location to maximize signal strength.



Demo for use with HMI
(HMI needs to be purchased separately)

Network	WiFi	IEEE 802.11b IEEE 802.11g IEEE 802.11n
I/O Port	SMA Female Connector	1
	Male Connector to HMI	1
Power	Input Power	5VDC
	Power Consumption	900mA@5VDC (powered by HMI)
	Voltage Resistance	500VAC (1min.)
	Isolation Resistance	Exceed 50MΩ at 500VDC
Specification	PCB Coating	N/A
	Enclosure	Plastic
	Dimensions WxHxD	54.5 x 80 x 24.1 mm
	Weight	Approx. 80 g
	Mount	HMI connector + diagonal screw fastening
Environment	Protection Structure	M02: IP20 Compliant Antenna: IP66 Compliant
	Storage Temperature	-20° ~ 60°C (-4° ~ 140°F)
	Operating Temperature	0° ~ 50°C (32° ~ 122°F)
	Relative Humidity	10% ~ 90% (non-condensing)
	Vibration Endurance	10 to 25Hz (X, Y, Z direction 2G 30 minutes)
Certificate	CE	CE marked
Software		EasyBuilder Pro

1.2 Dimensions

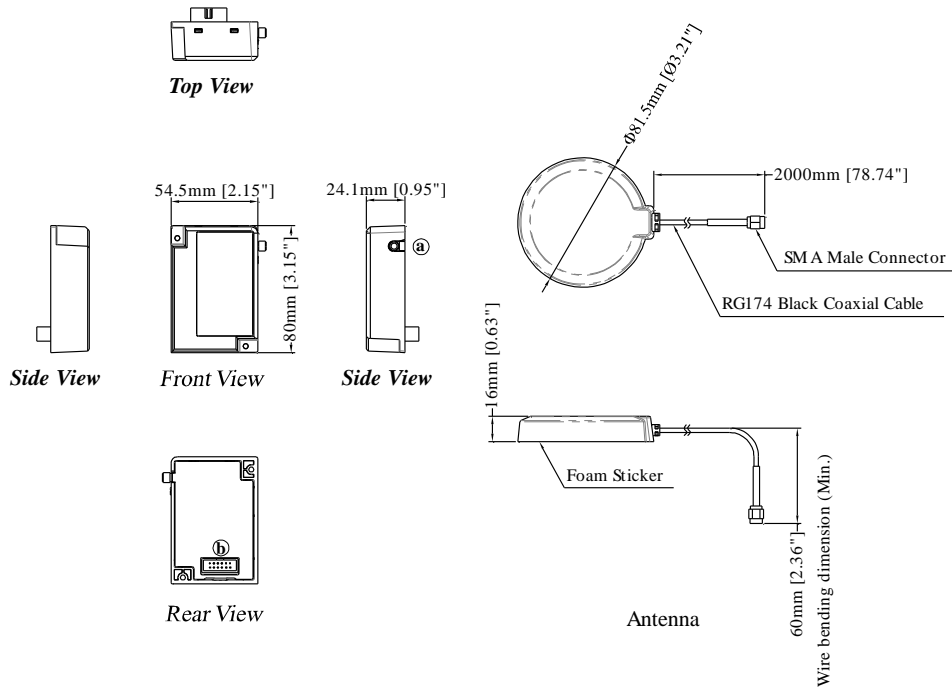

a	SMA Female Connector
b	Male Connector to HMI

1.3 Installation

M02 does not support hot swapping by design. Please connect it to HMI before powering up HMI.

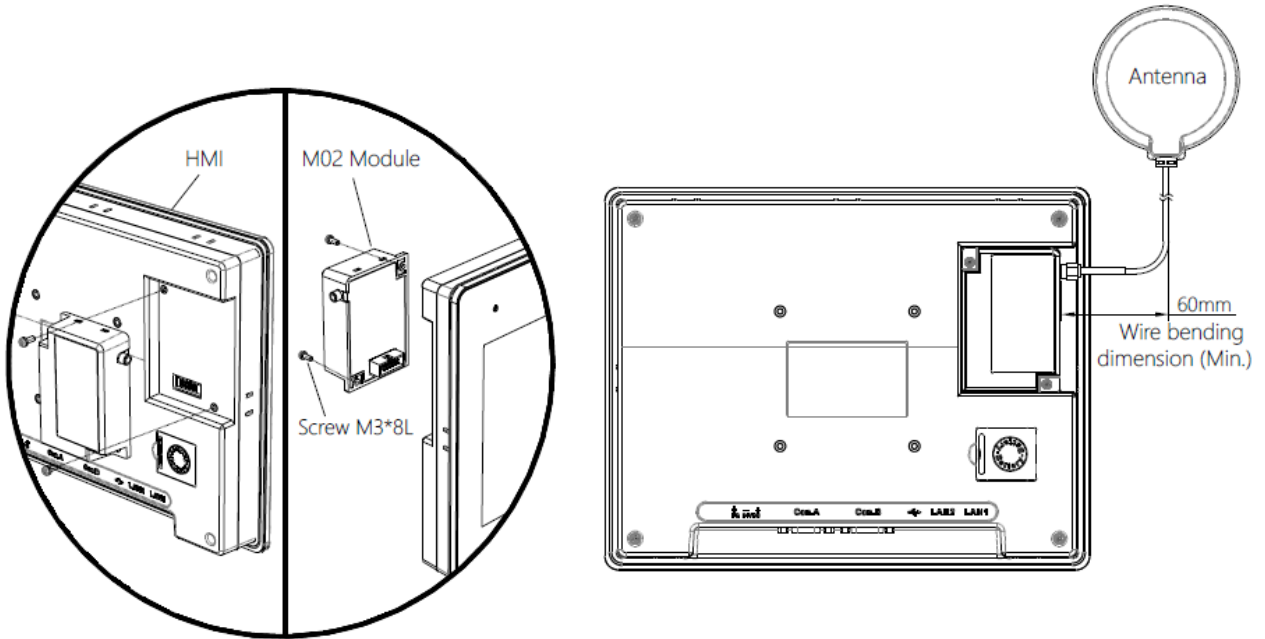

Chapter 2 Wi-Fi Settings

Connect M02 to HMI and then start up HMI. Log in system settings in one of the following two ways and configure Wi-Fi parameters.

2.1 Set in internet browser

Connect HMI with PC using an Ethernet cable, open internet browser (IE, Chrome, or Firefox), and enter HMI's IP address (e.g.: 192.168.2.177) to configure HMI settings.

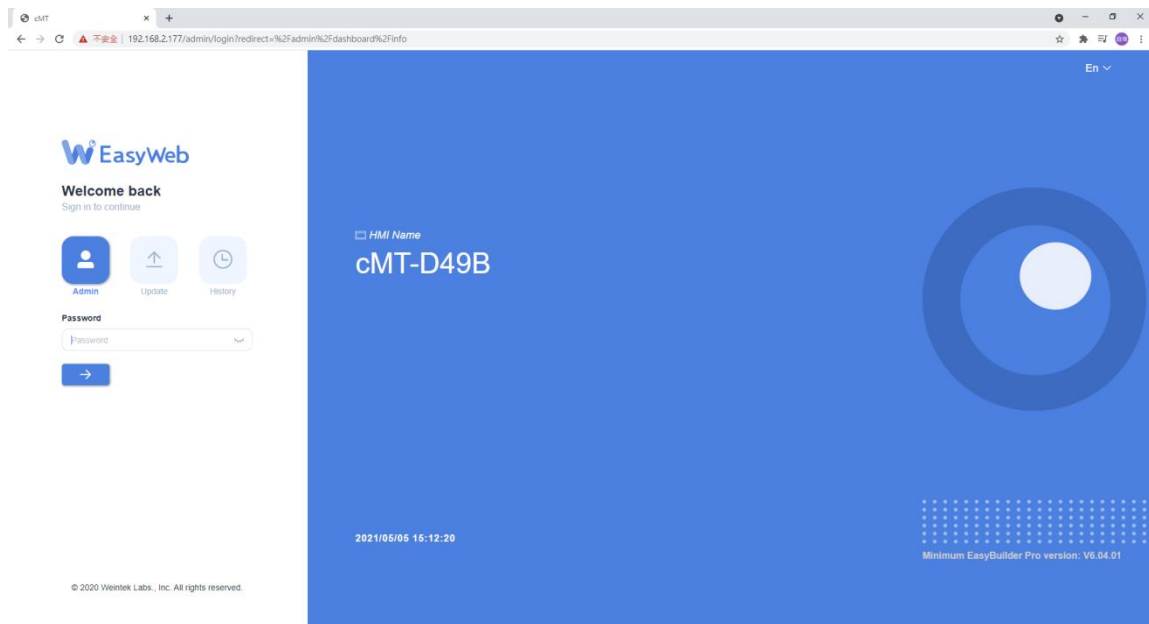

Network » Wi-Fi: Select Wi-Fi AP and define the encryption type.

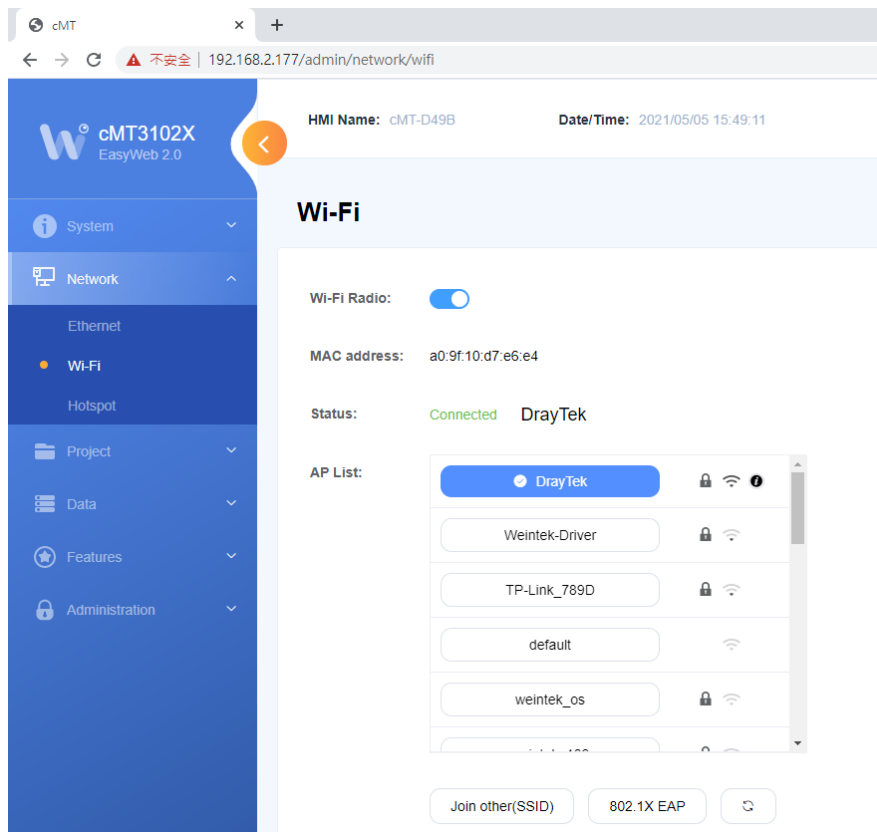

Network » Hotspot: Make the HMI a wireless hotspot to share internet connection if needed.

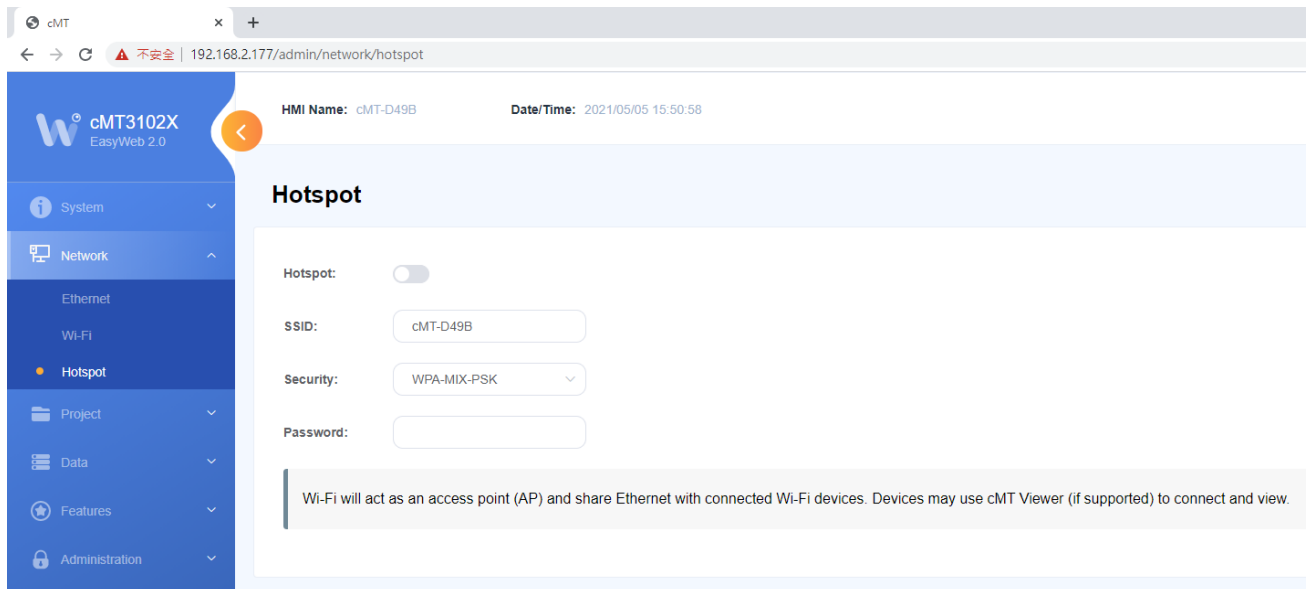

2.2 Set on HMI

Tap the round start button  on HMI to open the Setting window.



Tap the lock icon , enter the password to log in, and then open the Wi-Fi tab to set Wi-Fi Connection and Wi-Fi Hotspot.

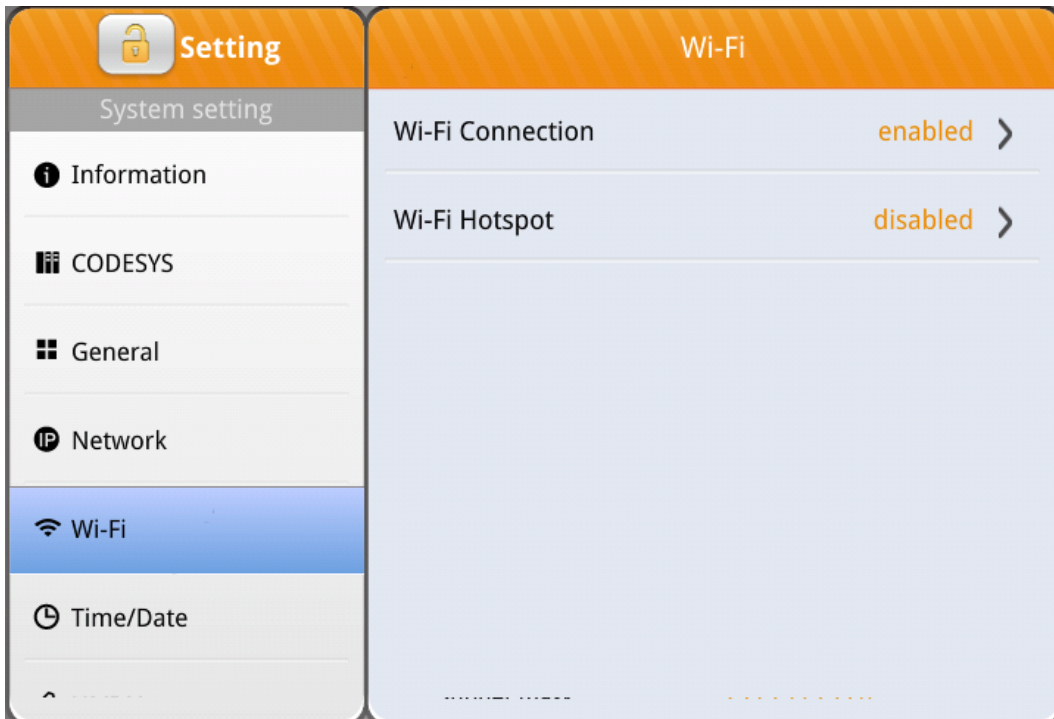

Wi-Fi Connection: Select Wi-Fi AP and define the encryption type.

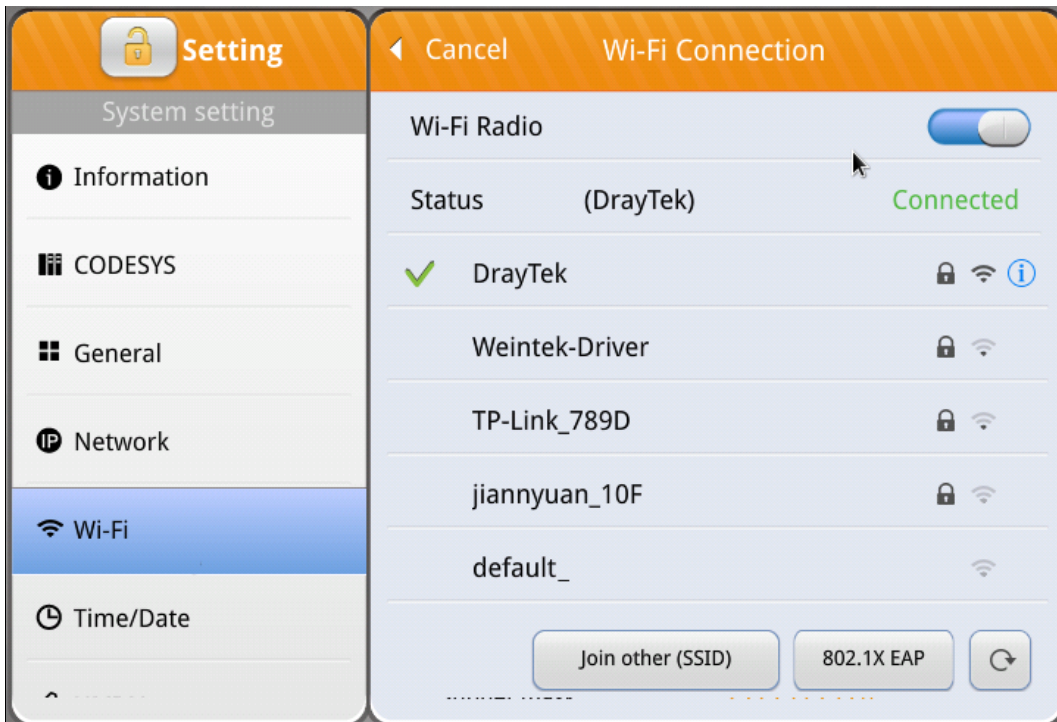

Wi-Fi Hotspot: Make the HMI a wireless hotspot to share internet connection if needed.

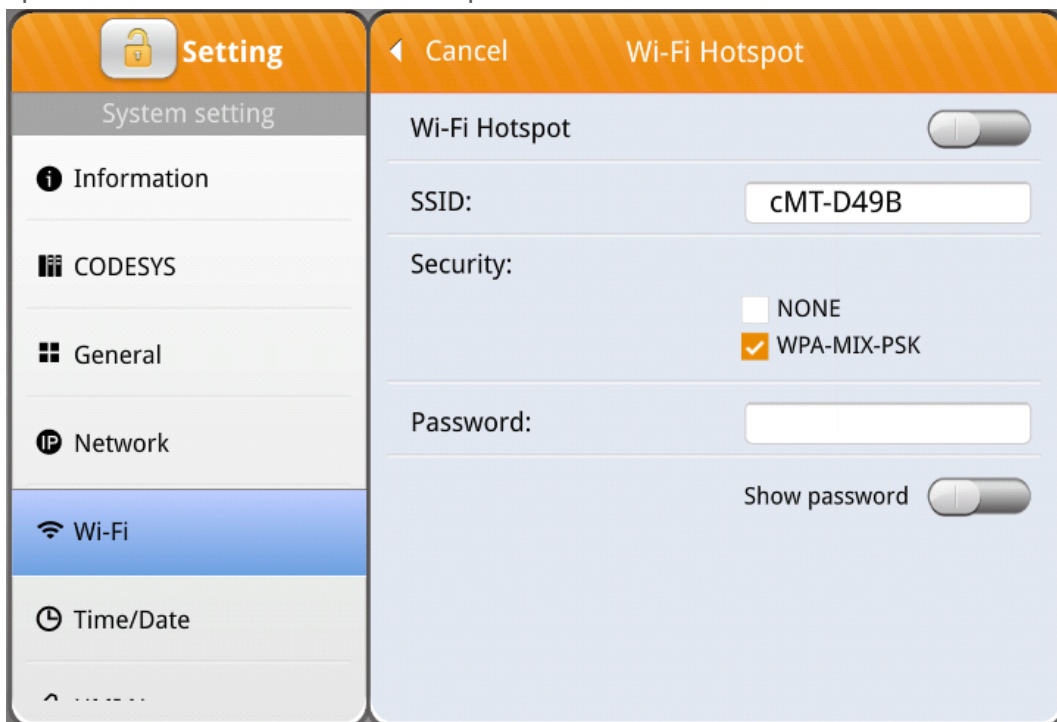

Note

- The IP address for Wi-Fi and the IP address for LAN1/LAN2 can belong to the same domain or different domains.
- A Wi-Fi hotspot's connection can be shared with up to 10 client devices at a time.

Other company names, product names, or trademarks in this document are the trademarks or registered trademarks of their respective companies. This document is subject to change without prior notice.