



Ethernet Communication Modules

CBES, CBEH-0A, CBEH-2A, CMEH, CM5EH

Catalog

Chapter 1.	Ethernet Communication Modules Introduction	5
1.1	Summary	5
1.2	FBs-CBES Main Function	6
1.2.1	Product Features	7
1.2.2	Product Appearance	8
1.2.3	PLC and CBES Communication Module Register Function Description	10
1.3	FBs-CBEH Main Function.....	12
1.3.1	Product Features	13
1.3.2	Product Appearance	14
1.3.3	PLC and CBEH Communication Module Register Function Description	17
1.4	FBs-CMEH Main Function	20
1.4.1	Product Features	21
1.4.2	Product Appearance	22
1.4.3	PLC and CMEH Communication Module Register Function Description	23
1.5	FBs-CM5EH Main Function	26
1.5.1	Product Features	27
1.5.2	Product Appearance	28
1.5.3	PLC and CM5EH Communication Module Register Function Description	29
1.6	Software Introduction	32
Chapter 2.	Basic Configuration Setting	36
2.1	Setting through Ethernet_Configuration_Tool software	36
2.1.1	Use Local Area Network to Connect with Internet	41
2.1.2	General Setting.....	43
2.1.3	Security Setting	45
2.1.4	Access Control Setting.....	46
2.1.5	Service Ports Setting	47
2.1.6	Port Mapping Setting	49
2.1.7	External Servers Setting	53
2.1.8	IoT Service	55
2.2	Setting Through Web Browser (not all modules supported).....	56
2.2.1	System Page	57
2.2.2	General Setting.....	58
2.2.3	Operation Mode Setting	60

2.2.4 Access Control Setting.....	61
2.2.5 Port Mapping	62
2.2.6 Service Ports.....	64
2.2.7 Security Setting	65
2.2.8 External Servers	66
Chapter 3. Advanced Setting	68
3.1 Customize Page Design	68
3.1.1 Change Page Layout	69
3.1.2 Add Menu	74
3.1.3 Add Content	77
3.1.4 Updating Customized Webpage.....	88
3.2 Sending Emails, Email to SMS	91
3.3 Internet Clock Synchronization	98
3.3.1 Enable the Internet Clock Synchronization Function.....	98
3.3.2 Synchronization of Real Time Clock with Network Time	99
3.3.3 Sample Application	100
3.4 Monitoring PLC's Internal Status Using System Webpage	101
3.4.1 Adding Monitoring Points	102
3.4.2 Modifying and Deleting Monitoring Points	103
3.4.3 Modify the Value of Monitoring Point	104
3.5 Active Call Back	105
3.5.1 Option Setting Page	106
3.5.2 Guest List.....	107
3.5.3 Active Call Back Application Example	109
3.6 FATEK IoT Service (iMonitor, iLocation).....	112
3.6.1 IoT Service Description	112
3.6.2 Activate Devices	113

Version	Revision date	Author	Detail
V1.0	2020/12/04	Calvin	
V1.1	2021/04/06	Calvin	

Chapter 1. Ethernet Communication Modules Introduction

1.1 Summary

This series is a small size CPU communication expansion board that does not occupy additional module space. With this expansion board, the FBs-CPU module can actively (client mode) or passive (server mode) communicate with the controller or computer on the Internet through Ethernet. This expansion board is suitable for all FBs-CPU modules. With this expansion board, the purpose of PLC remote monitoring and diagnosis can be easily achieved

When do the application, this expansion board will occupy the Port 1 and Port 2 communication ports of the host. Port2 is used to support Modbus-TCP server mode, FATEK client mode, user server mode, and user client mode. When in operating mode, Port1 and Port2 communication parameters will be automatically planned according to the set operating mode.

Provide Web Server function, besides using browser to set up configuration content, also provides users with the ability to design and operate simple web pages by themselves. Through this function, users can easily read or control the PLC status from a customized web page.

Floating IP is not easy to master and over-professional network firewall settings are one of the problems faced by remote network maintenance applications. Providing automatic maintenance of the service call back server (Service Call Back) function can completely eliminate this trouble. If it is only used for remote maintenance, it can be used immediately without setting in most cases.

When a situation occurs on site, the SMTP server of this expansion board can be used to send emails to notify remote maintenance personnel, or use the network service of email to text (SMS to Text) to send to the maintenance personnel in real-time with SMS mode.

FATEK IoT provides iMonitor service, which monitors equipment scattered in different regions at the same time, records data and trend graphs at a fixed time, and provides SMS, Email, and APP push to users if an alarm occurs in the first time.

Note	
	<ol style="list-style-type: none">1. External Servers, IoT functions do not support all modules, details will be explained in the following chapters.2. The operation mode of the communication port is different for different modules, details will be explained in the following chapters.

1.2 FBs-CBES Main Function

PLC Network Data Communication

FBs-CBES series expansion board provides the solution for the PLC network connection, reaching the FATEK or Modbus application by Port 1 and Port 2 of the expansion board.

FATEK IoT Service

Provides iMonitor remote monitor features, easily reach the IoT application without gateway or HMI.

Note	
	1. Default factory IP: 192.168.2.3

Note	
	1. FBs-CBES board series do not support the following features: <ul style="list-style-type: none">① Customize webpage design② Email sending③ Simple Network Time Protocol (SNTP)④ Remote maintenance- Active Call Back

1.2.1 Product Features

- Provides FATEK IoT iMonitor remote monitor solution
- Supports Multi-client simultaneous accessible function
- Provides FATEK Server and Client operation modes
- Provides Modbus Server operation modes
- 10/100 BaseT Ethernet interface
- IP access restriction security mechanism
- TCP/IP supports 8 connections (Server operation mode)

Note	
	<ol style="list-style-type: none">1. When FATEK client function is selected, Modbus server will not be provided.2. Enable iMonitor function will occupy one of the 8 connections.3. Use Fun150 Mode 0 to communicate with module will not occupy any connections.

1.2.2 Product Appearance

The appearance and functional parts of the FBs-CBES series expansion board are introduced as follows:

➤ FBs-CBES:

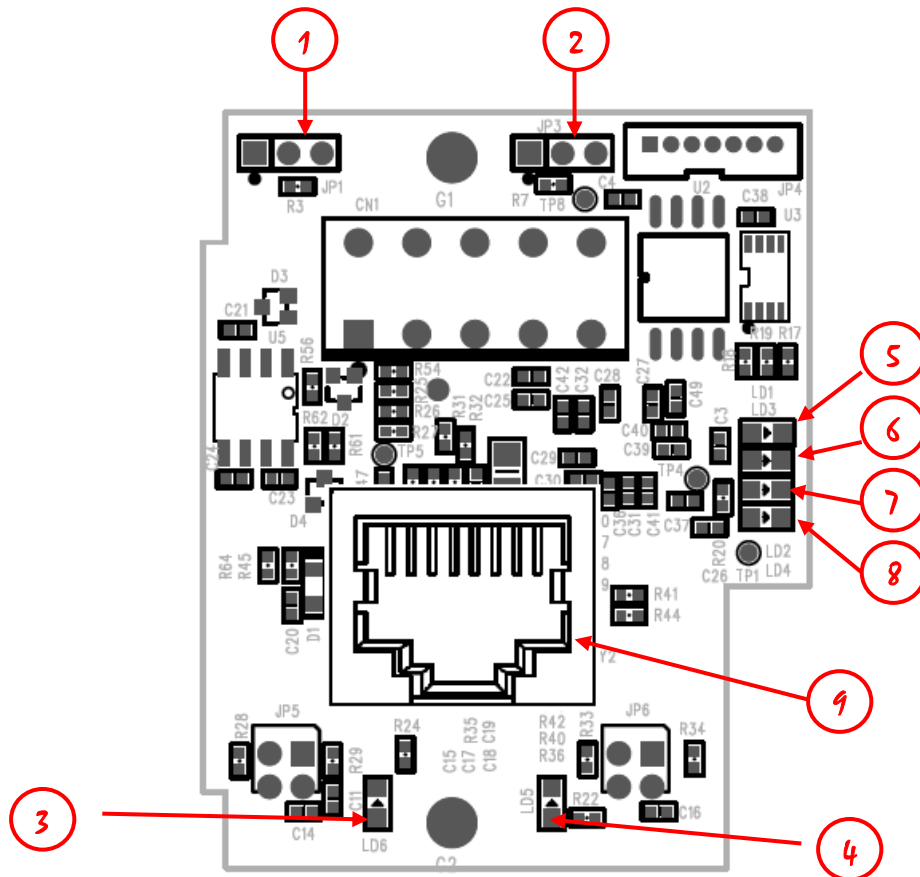

- ① NP jumper: When the left two pin headers are short circuit, no password protection.
- ② Boot jumper: When the right two pin headers are short circuit, forced to enter Boot operation mode after booting.
- ③ Ethernet status indicators (Link): Lights on means the network connection is normal, flash means there has data activity on the network.
- ④ Ethernet status indicators (Speed): Lights on means the connection speed is 100Base-TX, off means 10Base-T.
- ⑤ Port1 RX green signal indicator of the CPU module: Lights on means CPU module port1 has sent messages to the board.
- ⑥ Port1 TX red signal indicator of the CPU module: Lights on means the board has sent messages to the CPU module port1.

- ⑦ Port1 RX green signal indicator of the CPU module: Lights on means CPU module port2 has sent messages to the board.
- ⑧ Port2 TX red signal indicator of the CPU module: Lights on means the board has sent messages to the CPU module port2.
- ⑨ Ethernet connector: RJ45 standard connector.

1.2.3 PLC and CBES Communication Module Register Function Description

The communication between the PLC module and the CBES communication board during application is through data exchange in the CPU register area D3950~D3999. The function configuration of each register in this area is as follows:

Register	Description	
D3950	Initialization setting command code	
	Setting value	Status
	0x3450	Reset module. When the local network parameter is changed, it can be reset without turning off the power, and will be changed to zero after the command is executed.
	0x3451	Resets to factory settings. It will be changed to zero after the command is executed.

Service Ports	
D3975	Fatek Protocol (Major Port), when setting under D3990 = 0x4951, need to reboot
D3976	Modbus Protocol (Major Port), when setting under D3990 = 0x4951, need to reboot
Local Network Parameter <small>Note*2</small>	
Register	Description
D3986	1 st decimal number of the local network mask (MY_MASK.A)
D3987	2 nd decimal number of the local network mask (MY_MASK.B)
D3988	3 rd decimal number of the local network mask (MY_MASK.C)
D3989	4 th decimal number of the local network mask (MY_MASK.D)
D3990 (CPU write) Note*1	Local network parameter setting mode =0x4950 or 0x4951, Network parameters are determined by register contents. =0x4960, Obtain by DHCP. =other value, Determined by the contents of the configuration tool.
D3991	1 st decimal number of the board's network address (MY_IP.A)
D3992	2 nd decimal number of the board's network address (MY_IP.B)
D3993	3 rd decimal number of the board's network address (MY_IP.C)
D3994	4 th decimal number of the board's network address (MY_IP.D)
D3995	1 st decimal number of the local router network address (ROUTER_IP.A)
D3996	2 nd decimal number of the local router network address (ROUTER_IP.B)
D3997	3 rd decimal number of the local router network address (ROUTER_IP.C)

D3998	4 th decimal number of the local router network address (ROUTER_IP.D)
D3999	Board's serial number (S/N)

Note*1: The values in this table is written from the CPU. For D3986~D3989 and D3991~D3999, all registers are written by this product series except for when D3990 is written as 0x4951.

Note*2: Example of the network address (IP) 192.168.2.1; 1st code: 192; 2nd code: 168; 3rd code: 2; 4th code: 1, When D3990 is not 0x4951, D3986~D3989 and D3991~D3998 will display the actual setting value after boot on.

1.3 FBs-CBEH Main Function

PLC Network Data Communication

Provides the solution for the PLC network connection, reaching the FATEK , Modbus, or user-defined communication application by Port 1 and Port 2 of the expansion board.

Customized Web Page Design

The provided web server, in addition to the built-in system web page, also allows users to easily read or control the status in the PLC through a customized page. This customized page can be easily designed by yourself using the software "Easy Web Desinger" which is provided with by product; it does not require HTML language or programming skills commonly used to write web pages.

Send Email (SMTP)

Provides the function of sending E-mail in the real-time maintenance. When a special situation occurs in the workstation, the ladder program can send an e-mail command to the board and then send an e-mail to notify the maintenance personnel. In addition, you can also achieve real-time notification of Mail to SMS by providing E-mail interface with SMS sending function.

Network Time Correction (SNTP)

Provides the function of network time correction, which can avoid the trouble of manually correcting the time on a regular basis.

Remote Maintenance- Active Call Back

Provide a software "Service Call Center" to cooperate with the remote maintenance work. When the IP address of the PLC workstation is obtained by floating IP (DHCP) or when it is obtained in a more complex network environment (firewall), this software can be used for maintenance.

Note	
	1. FBs-CBEH board series do not support the following features: ① FATEK IoT Service

1.3.1 Product Features

- Supports Multi-client simultaneous accessible function
- Provides FATEK Server and Client operation modes
- Provides Modbus Server and Client operation modes
- Provides user-defined Server and Client operation modes
- 10/100 BaseT Ethernet interface
- IP access restriction security mechanism
- Provides web page server
- Provide a browser for module configuration settings
- Provide EasyWeb simple and fixed webpage design tool. Users do not need to have webpage-related skills to design and operate webpages by themselves
- Remote maintenance of the active callback function, eliminating the trouble of network settings
- Provides network automatic time correction (SNTP), which eliminates the trouble of manually calibrating the time on a regular basis
- Provides sending Email function. The purpose of sending SMS can be achieved through the Email to SMS network service.
- Provides two 12-bit ADC channels (only supported by the 2A module)
- TCP/IP supports 8 connections (Server operation mode)

Note	
	1. Default factory IP: 192.168.2.3

Note	
	<ol style="list-style-type: none">1. When FATEK client function is selected, Modbus server or Client function will not be provided.2. Use Fun150 Mode 0 to communicate with module will not occupy any connections.3. For web page operations, please use Firefox 8.0, Google Chrome 16.0.912.75 and above browsers.

1.3.2 Product Appearance

The appearance and functional parts of the FBs-CBEH series expansion board are introduced as follows:

➤ FBs-CBEH-0A:

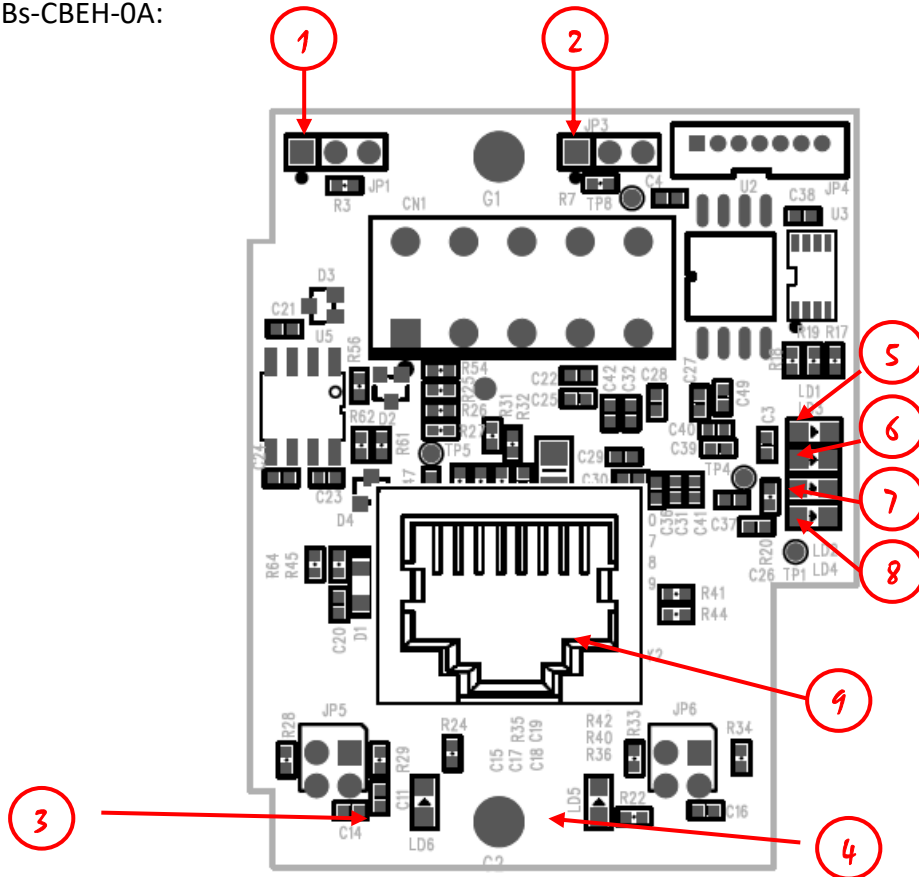

- ① NP jumper: When the left two pin headers are short circuit, no password protection. (If the firmware version is less than V7.6, the NP mode will be not connected to the jumper)
- ② Boot jumper: When the right two pin headers are short circuit, forced to enter Boot operation mode after booting.
- ③ Ethernet status indicators (Link): Lights on means the network connection is normal, flash means there has data activity on the network.
- ④ Ethernet status indicators (Speed): Lights on means the connection speed is 100Base-TX, off means 10Base-T.
- ⑤ Port1 RX green signal indicator of the CPU module: Lights on means CPU module port1 has sent messages to the board.
- ⑥ Port1 TX red signal indicator of the CPU module: Lights on means the board has sent messages to the CPU module port1.
- ⑦ Port1 RX green signal indicator of the CPU module: Lights on means CPU

module port2 has sent messages to the board.

- ⑧ Port2 TX red signal indicator of the CPU module: Lights on means the board has sent messages to the CPU module port2.
- ⑨ Ethernet connector: RJ45 standard connector.

➤ FBs-CBEH-2A :

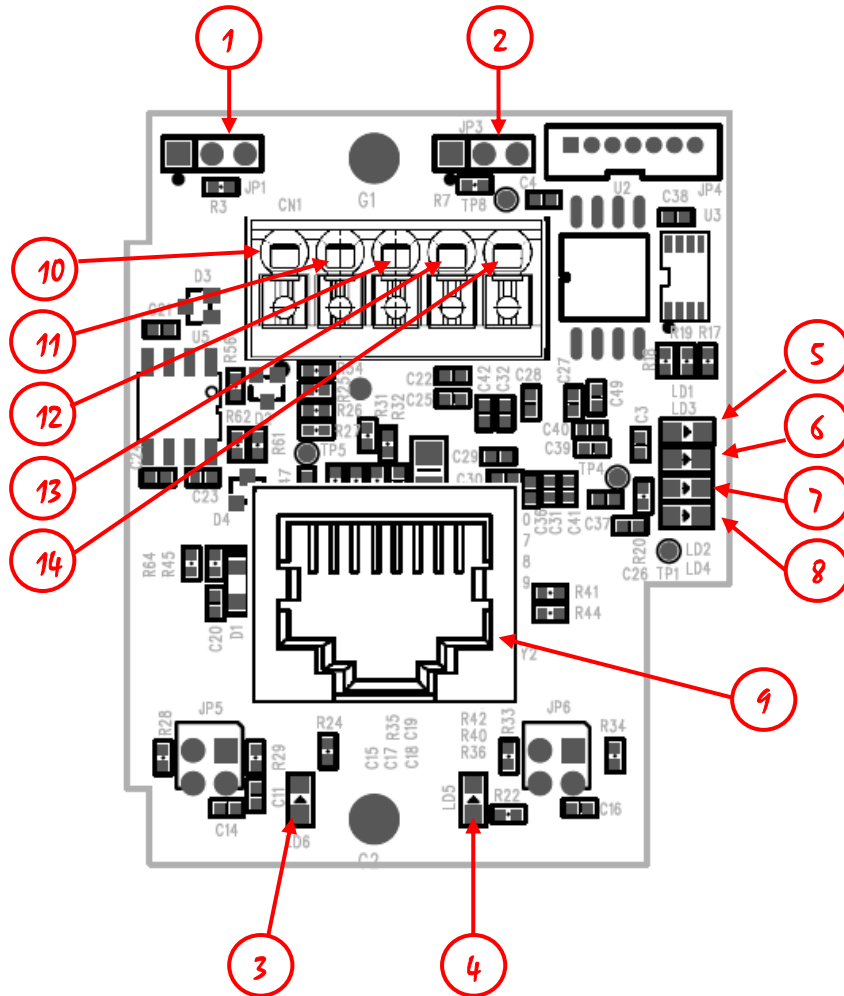

- ① NP jumper: When the left two pin headers are short circuit, no password protection. (If the firmware version is less than V7.6, the NP mode will be not connected to the jumper)
- ② Boot jumper: When the right two pin headers are short circuit, forced to enter Boot operation mode after booting.
- ③ Ethernet status indicators (Link): Lights on means the network connection is normal, flash means there has data activity on the network.
- ④ Ethernet status indicators (Speed): Lights on means the connection speed is 100Base-TX, off means 10Base-T.
- ⑤ Port1 RX green signal indicator of the CPU module: Lights on means CPU module port1 has sent messages to the board.

- ⑥ Port1 TX red signal indicator of the CPU module: Lights on means the board has sent messages to the CPU module port1.
- ⑦ Port1 RX green signal indicator of the CPU module: Lights on means CPU module port2 has sent messages to the board.
- ⑧ Port2 TX red signal indicator of the CPU module: Lights on means the board has sent messages to the CPU module port2.
- ⑨ Ethernet connector: RJ45 standard connector.
- ⑩ ADC port first group voltage input (0 ~ 10V) *₁
- ⑪ ADC port first group current input (0 ~ 20mA) *₁
- ⑫ ADC port second group voltage input (0 ~ 10V) *₁
- ⑬ ADC port second group current input (0 ~ 20mA)*₁
- ⑭ ADC GND

Note*₁: The voltage and current of the same group of the ports cannot be input at the same time.

1.3.3 PLC and CBEH Communication Module Register Function

Description

The communication between the PLC module and the CBEH communication board during application is through data exchange in the CPU register area D3950~D3999. The function configuration of each register in this area is as follows:

Active Call Back			
Register	Description		
D3950 (CPU Note*1)	Active callback and initial setting command code		
	Setting value	Status	
	0x3359	Execute active call back, set 0 to end up connection	
	0x3450	Reset module. When the local network parameters are changed, they can be reset without turning off the power, and they will become zero after the command is executed.	
	0x3451	Reset to factory setting. It will become zero after the command is executed.	
D3951	Call Status		
	Setting value	Status	
	0	Standby	
	1	Connecting	
	2	Connected	
	5	Connection failed	
	6	Connection refused	
	7	Certificating	
	8	Connection ended	
Network Time Synchronization			
Register	Description		
D3952	Daylight time	Set whether to use daylight saving time currently 0 - Standard time 1 - Daylight saving time	
D3953	NTP Calendar	Second	Value range 0~59
D3954		Minute	Value range 0~59
D3955		Hour	Value range 0~23
D3956		Day	Value range 1~31

D3957		Month	Value range 1~12
D3958		Year	Value range 0~99
D3959		Week Day	Value range 0~6
D3960	Update Flag		NTP Calendar updates every 10 minutes, and the flag value is increased by 1 after each update. By detecting the change of this flag, the timing of time synchronization can be determined

Sending Email

Register	Description	
D3961 (CPU Note*1)	Email command code	
	Setting value	Status
	0x3370	Execute email transmission, need to fill 0 after completion.
D3962 (CPU Note*1)	Email number to be sent	
D3963	Email transmission status	
	Setting value	Status
	0	Standby
	1	Executing
	2	Transmission Complete
	10	Email Number Error
	11	Transmission Failed
	12	Incorrectly Constructed Information

ADC Value

D3964	ADC0
D3965	ADC1

Modbus Client Time Out (Unit: 10ms, Default: 50ms)

Register	Description
D3977	When a communication abnormality occurs, the waiting time before the connection is terminated and an error occurs

Local Network Parameter note*2

Register	Description
D3978~D3981	Primary DNS IP
D3982~D3985	Secondary DNS IP
D3986	1 st decimal number of the local network mask (MY_MASK.A)
D3987	2 nd decimal number of the local network mask (MY_MASK.B)
D3988	3 rd decimal number of the local network mask (MY_MASK.C)
D3989	4 th decimal number of the local network mask (MY_MASK.D)
D3990	Local network parameter setting mode

(CPU) Note*1	=0x4950 or 0x4951, Network parameters are determined by register contents. =0x4960, Obtain by DHCP. =other value, Determined by the contents of the configuration tool.
D3991	1 st decimal number of the local network address (MY_IP.A)
D3992	2 nd decimal number of the local network address (MY_IP.B)
D3993	3 rd decimal number of the local network address (MY_IP.C)
D3994	4 th decimal number of the local network address (MY_IP.D)
D3995	1 st decimal number of the local router network address (ROUTER_IP.A)
D3996	2 nd decimal number of the local router network address (ROUTER_IP.B)
D3997	3 rd decimal number of the local router network address (ROUTER_IP.C)
D3998	4 th decimal number of the local router network address (ROUTER_IP.D)
D3999	Board's serial number (S/N)

Note*1: The values in this table is written from the CPU. For D3978~D3989 and D3991~D3999, all registers are written by this product series except for when D3990 is written as 0x4951.

Note*2: Example of the network address (IP) 192.168.2.1; 1st code: 192; 2nd code: 168; 3rd code: 2; 4th code: 1, When D3990 is not 0x4951, D3978~D3989 and D3991~D3998 will display the actual setting value after boot on.

1.4 FBs-CMEH Main Function

PLC Network Data Communication

Provides the solution for the PLC network connection, reaching the FATEK, Modbus, or user-defined communication application by Port 3 and Port 4 of the expansion board.

Customized Web Page Design

The provided web server, in addition to the built-in system web page, also allows users to easily read or control the status in the PLC through a customized page. This customized page can be easily designed by yourself using the software "Easy Web Designer" which is provided with by product; it does not require HTML language or programming skills commonly used to write web pages.

Send Email (SMTP)

Provides the function of sending E-mail in the real-time maintenance. When a special situation occurs in the workstation, the ladder program can send an e-mail command to the board and then send an e-mail to notify the maintenance personnel. In addition, you can also achieve real-time notification of Email to SMS by providing Email interface with SMS sending function.

Network Time Correction (SNTP)

Provides the function of network time correction, which can avoid the trouble of manually correcting the time on a regular basis.

Remote Maintenance- Active Call Back

Provide a software "Service Call Center" to cooperate with the remote maintenance work. When the IP address of the PLC workstation is obtained by floating IP (DHCP) or when it is obtained in a more complex network environment (firewall), this software can be used for maintenance.

Note	
	<ol style="list-style-type: none">1. FBs-CMEH board series do not support the following features:<ul style="list-style-type: none">● FATEK IoT Service

1.4.1 Product Features

- Supports Multi-client simultaneous accessible function
- Provides FATEK Server and Client operation modes
- Provides Modbus Server and Client operation modes
- Provides user-defined Server and Client operation modes
- 10/100 BaseT Ethernet interface
- IP access restriction security mechanism
- Provides web page server
- Provide a browser for module configuration settings
- Provide EasyWeb simple and fixed webpage design tool. Users do not need to have webpage-related skills to design and operate webpages by themselves
- Remote maintenance of the active callback function, eliminating the trouble of network settings
- Provides network automatic time correction (SNTP), which eliminates the trouble of manually calibrating the time on a regular basis
- Provides sending Email function. The purpose of sending SMS can be achieved through the Email to SMS network service.
- TCP/IP supports 8 connections (Server operation mode)

Note	
	1. Default factory IP: 192.168.2.3

Note	
	<ol style="list-style-type: none">1. When FATEK client function is selected, Modbus server or Client function will not be provided.2. Use Fun150 Mode 0 to communicate with module will not occupy any connections.3. For web page operations, please use Firefox 8.0, Google Chrome 16.0.912.75 and above browsers.

1.4.2 Product Appearance

The appearance and functional parts of the FBs-CMEH communication module are introduced as follows:

➤ FBs-CMEH

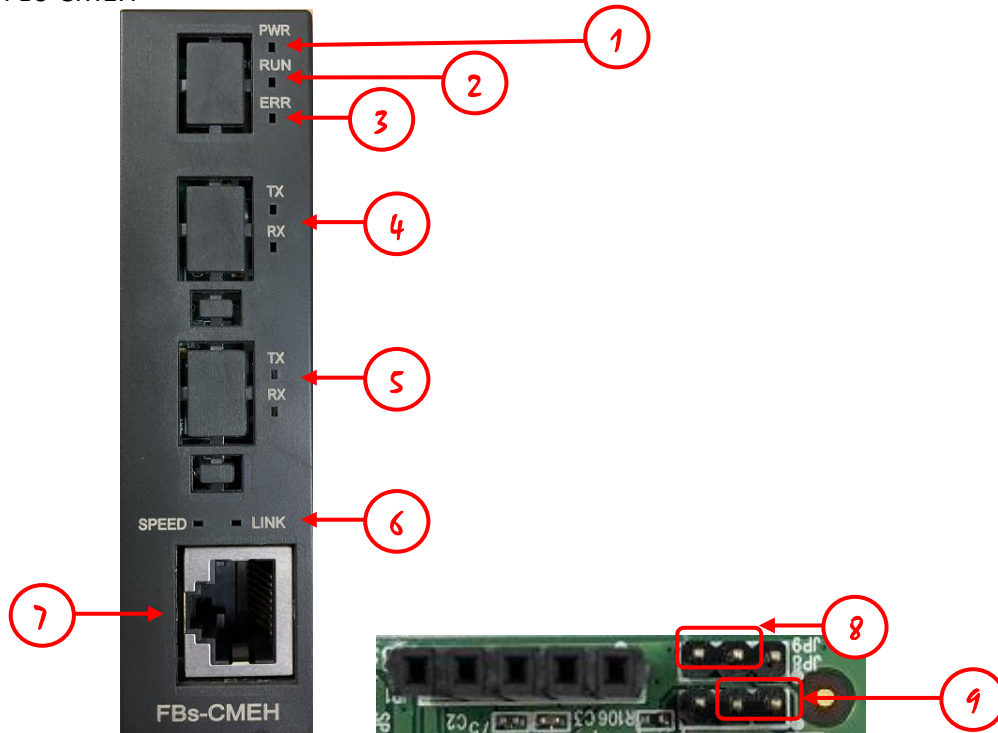

- ① Power indicator: Stays light when power on.
- ② System running indicator: Normal situation would be flashing.
- ③ Error indicator: It will stay light when the baud rate automatic adjustment with PLC communication port 3 fails.
- ④ Port 4 R/TX: Display the current status of communication with PLC Port 4.
- ⑤ Port 3 R/TX: Display the current status of communication with PLC Port 3.
- ⑥ Ethernet status indicators: Speed means connection speed, Link means connection and data activity.
- ⑦ Ethernet port: Ethernet cable port.
- ⑧ Boot jumper: When the left two pin headers are short circuit, forced to enter Boot operation mode after booting.
- ⑨ NP jumper: When the right two pin headers are short circuit, no password protection.

1.4.3 PLC and CMEH Communication Module Register Function

Description

The communication between the PLC module and the CMEH communication board during application is through data exchange in the CPU register area D3950~D3999. The function configuration of each register in this area is as follows:

Active Call Back			
Register	Description		
D3950 (CPU Note *1)	Active callback and initial setting command code		
	Setting value	Status	
	0x3359	Execute active call back, set 0 to end up connection	
	0x3450	Reset module. When the local network parameters are changed, they can be reset without turning off the power, and they will become zero after the command is executed.	
	0x3451	Reset to factory setting. It will become zero after the command is executed.	
D3951	Call Status		
	Setting value	Status	
	0	Standby	
	1	Connecting	
	2	Connected	
	5	Connection failed	
	6	Connection refused	
	7	Certificating	
	8	Connection ended	
Network Time Synchronization			
Register	Description		
D3952	Daylight time	Set whether to use daylight saving time currently 0 - Standard time 1 - Daylight saving time	
D3953	NTP Calendar	Second	Value range 0~59
D3954		Minute	Value range 0~59
D3955		Hour	Value range 0~23
D3956		Day	Value range 1~31

D3957		Month	Value range 1~12
D3958		Year	Value range 0~99
D3959		Week Day	Value range 0~6
D3960	Update Flag		NTP Calendar updates every 10 minutes, and the flag value is increased by 1 after each update. By detecting the change of this flag, the timing of time synchronization can be determined

Sending Email		
Register	Description	
D3961 (CPU Note*1)	Email command code	
	Setting value	Status
	0x3370	Execute email transmission, need to fill 0 after completion.
D3962 (CPU Note*1)	Email number to be sent	
D3963	Email transmission status	
	Setting value	Status
	0	Standby
	1	Executing
	2	Transmission Complete
	10	Email Number Error
	11	Transmission Failed
	12	Incorrectly Constructed Information

Modbus Client Time Out (Unit: 10ms, Default: 50ms)

Register	Description
D3977	When a communication abnormality occurs, the waiting time before the connection is terminated and an error occurs

Local Network Parameter note*2

Register	Description
D3978~D3981	Primary DNS IP
D3982~D3985	Secondary DNS IP
D3986	1 st decimal number of the local network mask (MY_MASK.A)
D3987	2 nd decimal number of the local network mask (MY_MASK.B)
D3988	3 rd decimal number of the local network mask (MY_MASK.C)
D3989	4 th decimal number of the local network mask (MY_MASK.D)
D3990 (CPU) Note*1	Local network parameter setting mode =0x4950 or 0x4951, Network parameters are determined by register contents.

	=0x4960, Obtain by DHCP. =other value, Determined by the contents of the configuration tool.
D3991	1 st decimal number of the local network address (MY_IP.A)
D3992	2 nd decimal number of the local network address (MY_IP.B)
D3993	3 rd decimal number of the local network address (MY_IP.C)
D3994	4 th decimal number of the local network address (MY_IP.D)
D3995	1 st decimal number of the local router network address (ROUTER_IP.A)
D3996	2 nd decimal number of the local router network address (ROUTER_IP.B)
D3997	3 rd decimal number of the local router network address (ROUTER_IP.C)
D3998	4 th decimal number of the local router network address (ROUTER_IP.D)
D3999	Module's serial number (S/N)

Note*1: The values in this table is written from the CPU. For D3978~D3989 and D3991~D3999, all registers are written by this product series except for when D3990 is written as 0x4951.

Note*2: Example of the network address (IP) 192.168.2.1; 1st code: 192; 2nd code: 168; 3rd code: 2; 4th code: 1, When D3990 is not 0x4951, D3978~D3989 and D3991~D3998 will display the actual setting value after boot on.

1.5 FBs-CM5EH Main Function

PLC Network Data Communication

Provides the solution for the PLC network connection, reaching the FATEK, Modbus, application by Port 3 and Port 4 of the expansion board.

Customized Web Page Design

The provided web server, in addition to the built-in system web page, also allows users to easily read or control the status in the PLC through a customized page. This customized page can be easily designed by yourself using the software "Easy Web Designer" which is provided with by product; it does not require HTML language or programming skills commonly used to write web pages.

Send Email (SMTP)

Provides the function of sending E-mail in the real-time maintenance. When a special situation occurs in the workstation, the ladder program can send an e-mail command to the board and then send an e-mail to notify the maintenance personnel. In addition, you can also achieve real-time notification of Email to SMS by providing Email interface with SMS sending function.

Network Time Correction (SNTP)

Provides the function of network time correction, which can avoid the trouble of manually correcting the time on a regular basis.

Remote Maintenance- Active Call Back

Provide a software "Service Call Center" to cooperate with the remote maintenance work. When the IP address of the PLC workstation is obtained by floating IP (DHCP) or when it is obtained in a more complex network environment (firewall), this software can be used for maintenance.

Note	
	<ol style="list-style-type: none">1. FBs-CM5EH board series do not support the following features:<ul style="list-style-type: none">● FATEK IoT Service

1.5.1 Product Features

- Supports Multi-client simultaneous accessible function
- Provides FATEK Server operation modes
- Provides Modbus Server operation modes
- 10/100 BaseT Ethernet interface
- IP access restriction security mechanism
- Provides web page server
- Provide a browser for module configuration settings
- Provide EasyWeb simple and fixed webpage design tool. Users do not need to have webpage-related skills to design and operate webpages by themselves
- Remote maintenance of the active callback function, eliminating the trouble of network settings
- Provides network automatic time correction (SNTP), which eliminates the trouble of manually calibrating the time on a regular basis
- Provides sending Email function. The purpose of sending SMS can be achieved through the Email to SMS network service.
- TCP/IP supports 8 connections (Server operation mode)

Note	
	1. Default factory IP: 192.168.2.3

Note	
	<ol style="list-style-type: none">1. When FATEK server function is selected, Modbus server function will not be provided.2. Use Fun150 Mode 0 to communicate with module will not occupy any connections.3. Ethernet port and RS485 cannot do the connection at the same time4. For web page operations, please use Firefox 8.0, Google Chrome 16.0.912.75 and above browsers.

1.5.2 Product Appearance

The appearance and functional parts of the FBs-CM5EH communication module are introduced as follows:

➤ FBs-CM5EH

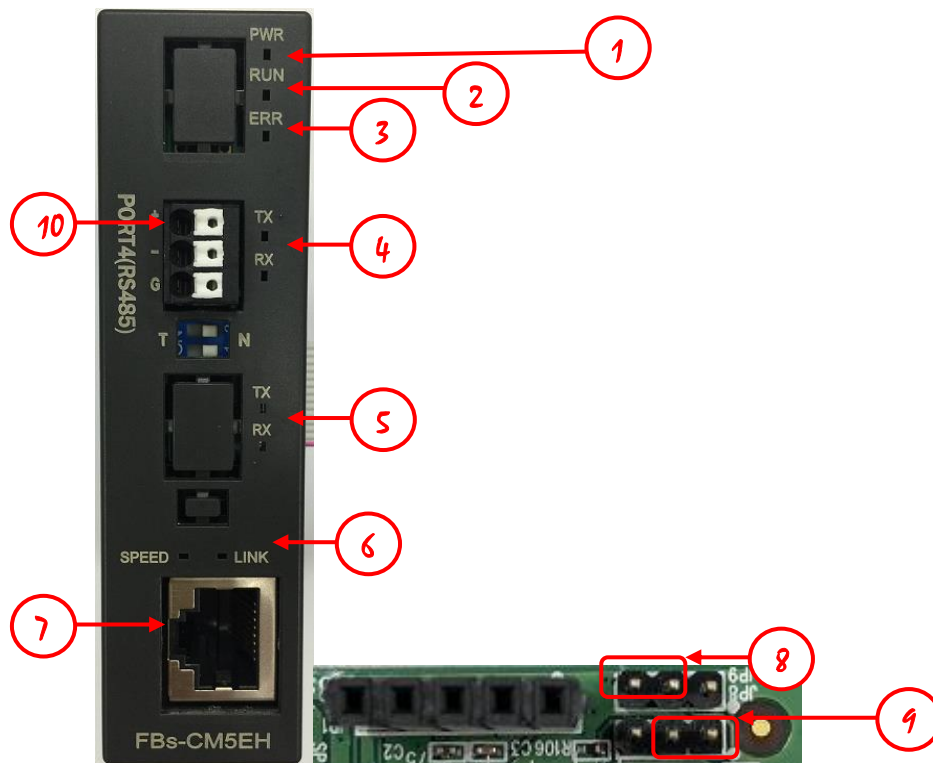

- ① Power indicator: Stays light when power on.
- ② System running indicator: Normal situation would be flashing.
- ③ Error indicator: It will stay light when the baud rate automatic adjustment with PLC communication port 3 fails.
- ④ Port 4 R/TX: Display the current status of communication with PLC Port 4.
- ⑤ Port 3 R/TX: Display the current status of communication with PLC Port 3.
- ⑥ Ethernet status indicators: Speed means connection speed, Link means connection and data activity.
- ⑦ Ethernet port: Ethernet cable port.
- ⑧ Boot jumper: When the left two pin headers are short circuit, forced to enter Boot operation mode after booting.
- ⑨ NP jumper: When the right two pin headers are short circuit, no password protection.
- ⑩ Port 4 (RS485): RS485 network port

1.5.3 PLC and CM5EH Communication Module Register Function

Description

The communication between the PLC module and the CM5EH communication board during application is through data exchange in the CPU register area D3950~D3999.

The function configuration of each register in this area is as follows:

Active Call Back			
Register	Description		
D3950 (CPU Note *1)	Active callback and initial setting command code		
	Setting value	Status	
	0x3359	Execute active call back, set 0 to end up connection	
	0x3450	Reset module. When the local network parameters are changed, they can be reset without turning off the power, and they will become zero after the command is executed.	
	0x3451	Reset to factory setting. It will become zero after the command is executed.	
D3951	Call Status		
	Setting value	Status	
	0	Standby	
	1	Connecting	
	2	Connected	
	5	Connection failed	
	6	Connection refused	
	7	Certificating	
	8	Connection ended	
Network Time Synchronization			
Register	Description		
D3952	Daylight time	Set whether to use daylight saving time currently 0 - Standard time 1 - Daylight saving time	
D3953	NTP Calendar	Second	Value range 0~59
D3954		Minute	Value range 0~59
D3955		Hour	Value range 0~23
D3956		Day	Value range 1~31

D3957		Month	Value range 1~12
D3958		Year	Value range 0~99
D3959		Week Day	Value range 0~6
D3960	Update Flag		NTP Calendar updates every 10 minutes, and the flag value is increased by 1 after each update. By detecting the change of this flag, the timing of time synchronization can be determined

Sending Email			
Register	Description		
D3961 (CPU Note*1)	Email command code		
	Setting value	Status	
	0x3370	Execute email transmission, need to fill 0 after completion.	
D3962 (CPU Note*1)	Email number to be sent		
D3963	Email transmission status		
	Setting value	Status	
	0	Standby	
	1	Executing	
	2	Transmission Complete	
	10	Email Number Error	
	11	Transmission Failed	
	12	Incorrectly Constructed Information	
Local Network Parameter <small>note*2</small>			
Register	Description		
D3978~D3981	Primary DNS IP		
D3982~D3985	Secondary DNS IP		
D3986	1 st decimal number of the local network mask (MY_MASK.A)		
D3987	2 nd decimal number of the local network mask (MY_MASK.B)		
D3988	3 rd decimal number of the local network mask (MY_MASK.C)		
D3989	4 th decimal number of the local network mask (MY_MASK.D)		
D3990 (CPU) Note*1	Local network parameter setting mode =0x4950 or 0x4951, Network parameters are determined by register contents. =0x4960, Obtain by DHCP. =other value, Determined by the contents of the configuration tool.		
D3991	1 st decimal number of the local network address (MY_IP.A)		
D3992	2 nd decimal number of the local network address (MY_IP.B)		
D3993	3 rd decimal number of the local network address (MY_IP.C)		

D3994	4 th decimal number of the local network address (MY_IP.D)
D3995	1 st decimal number of the local router network address (ROUTER_IP.A)
D3996	2 nd decimal number of the local router network address (ROUTER_IP.B)
D3997	3 rd decimal number of the local router network address (ROUTER_IP.C)
D3998	4 th decimal number of the local router network address (ROUTER_IP.D)
D3999	Module's serial number (S/N)

Note*1: The values in this table is written from the CPU. For D3978~D3989 and D3991~D3999, all registers are written by this product series except for when D3990 is written as 0x4951.

Note*2: Example of the network address (IP) 192.168.2.1; 1st code: 192; 2nd code: 168; 3rd code: 2; 4th code: 1, When D3990 is not 0x4951, D3978~D3989 and D3991~D3998 will display the actual setting value after boot on.

1.6 Software Introduction

➤ Ethernet_Configuration_Tool

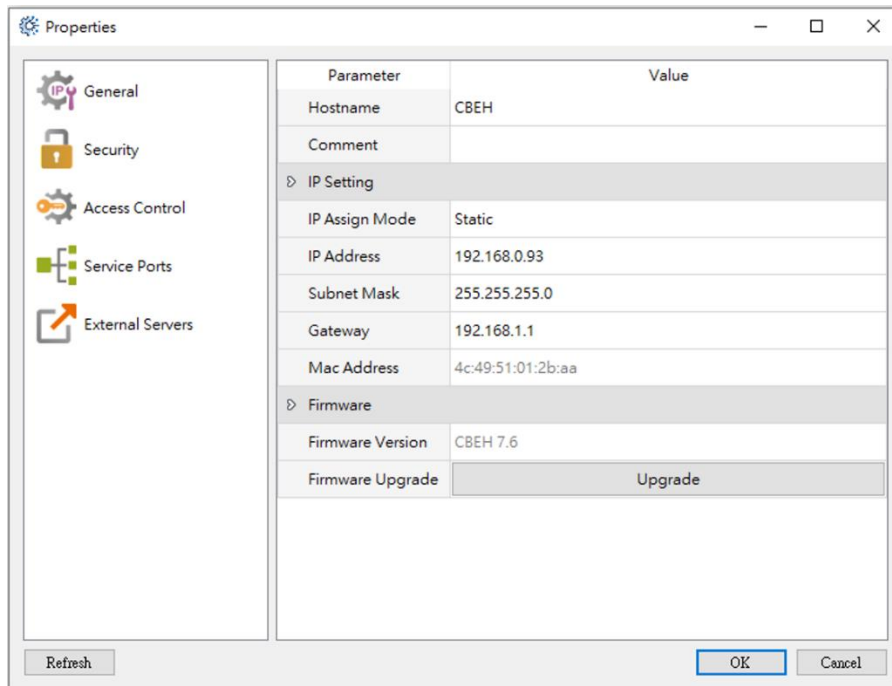
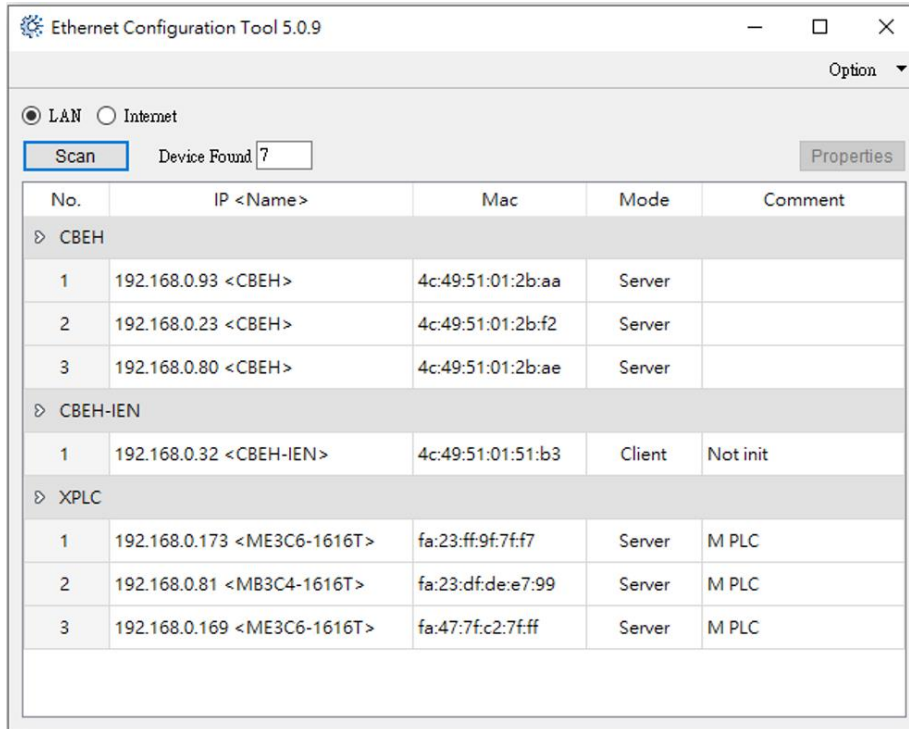

Provides window version setting software for communication modules setting basic configuration, password protection, and firmware upgrade, etc. For more details please refer to ch2.1

➤ Easy Web Designer

Provides 2 functions

1. Create customized web pages

Allow users to easily browse or control the status within the PLC through a customized web page; the customized web page can be created through this software without requiring the user to have the skills to write HTML. Please refer to chapter 3.1 for detailed explanation.

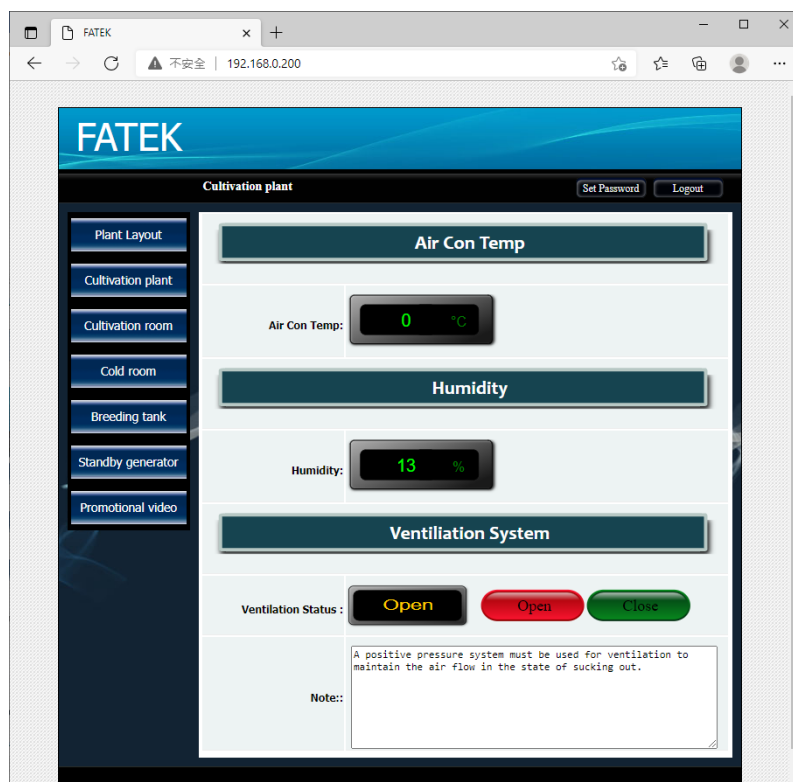
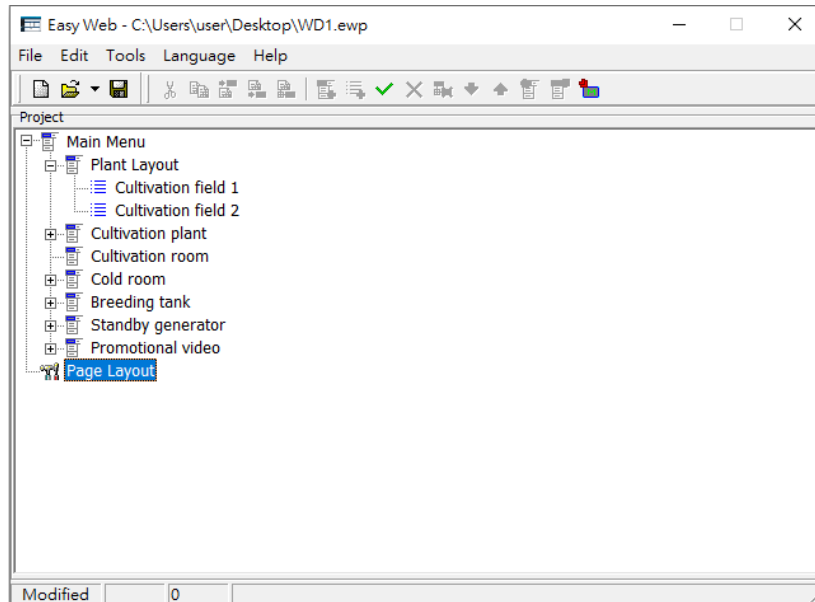

2. Email sending configuration data setting

In terms of maintenance immediacy, provides the Email sending and Email to SMS functions, which can be set through the windows tool “e-mail Editor” in Easy Web Designer. Please refer to chapter 3.2 for detailed operation contents.

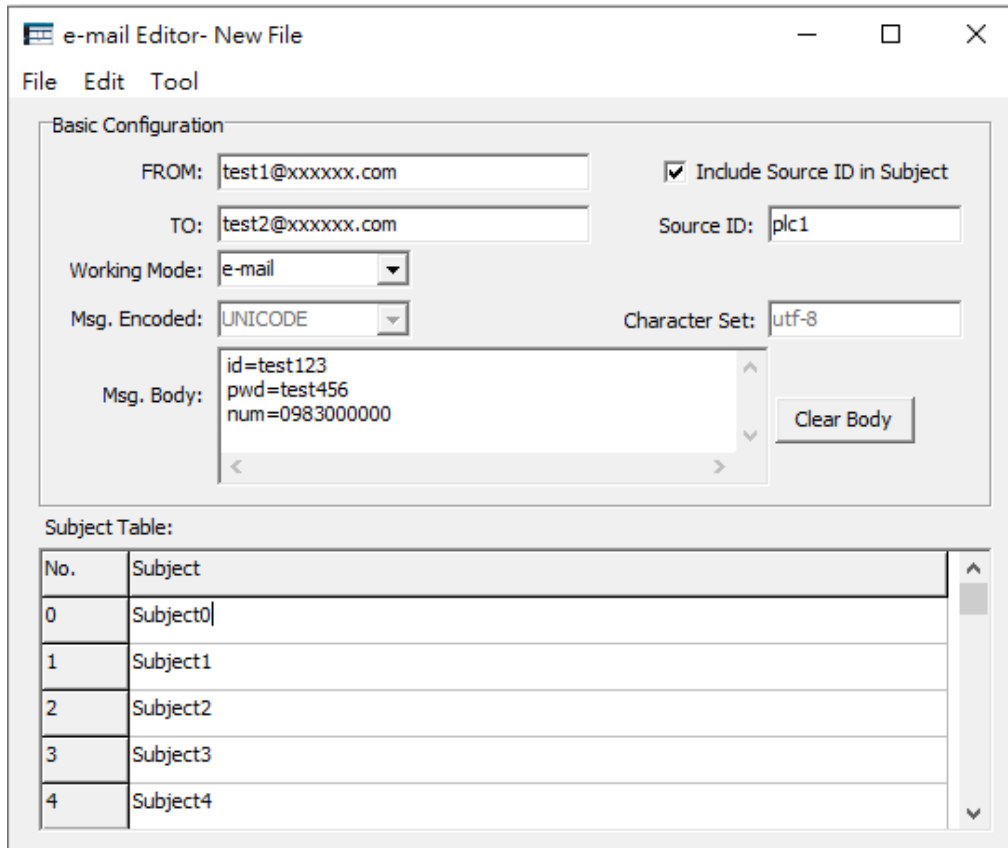

The screenshot shows the 'e-mail Editor- New File' window with the following configuration:

- FROM:** test1@xxxxxx.com
- TO:** test2@xxxxxx.com
- Working Mode:** e-mail
- Msg. Encoded:** UNICODE
- Character Set:** utf-8
- Include Source ID in Subject:**
- Source ID:** plc1
- Msg. Body:** id=test123
pwd=test456
num=0983000000
- Clear Body:** Button

Subject Table:

No.	Subject
0	Subject0
1	Subject1
2	Subject2
3	Subject3
4	Subject4

➤ Service Call Center

The Service Call Center software is provided to work with remote maintenance operations, used to perform maintenance tasks when the PLC workstation's IP is acquired with the dynamic IP method or when it is in a more complicated network environment and the IP is difficult to acquire. Please refer to chapter 3.5 for detailed operation contents.

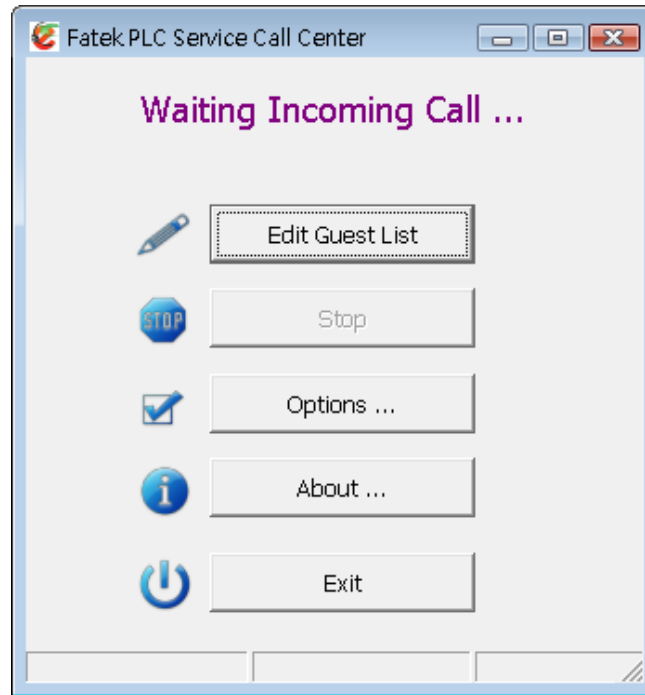

Note	
	The above functions only supported on FBs-CBEH, FBs-CMEH, and FBs-CM5EH

Chapter 2. Basic Configuration Setting

To set up the basic configuration of the modules, users can set it through Ethernet_Configuration_Tool software. Download from our website <https://www.fatek.com/zh-tw/download.php>

2.1 Setting through Ethernet_Configuration_Tool software

Ether_Config software provides the following features (V5.0.5 or above):

- Basic module parameter setting: Includes Host Name, network address, Gate Way, Subnet Mask, Operation Mode, and Comment, etc.
- Security setting: Grant IP (Network address) setting, the module and the expansion board will accept only when the command message sends by the grant IP.
- Local station number, remote network address and station number setting: The maximum number of the PLC slave stations that can be connected through the network is 254 stations, when the module is in the client mode, in order to map the local station number (For the main PLC) to the PLC slave station on the network, the mapping table must be set up first when doing the application.
- FATEK IoT Service: Provides iMonitor remote monitor service.
- External Server: Supports NTP Server, SMTP Server, and SVC automatically server call back functions.
- Firmware update function: Ether_Config software provides communication modules to update firmware.

Note	
	1. The old version of Config software does not support FBs-CBES firmware V10.1 or above.

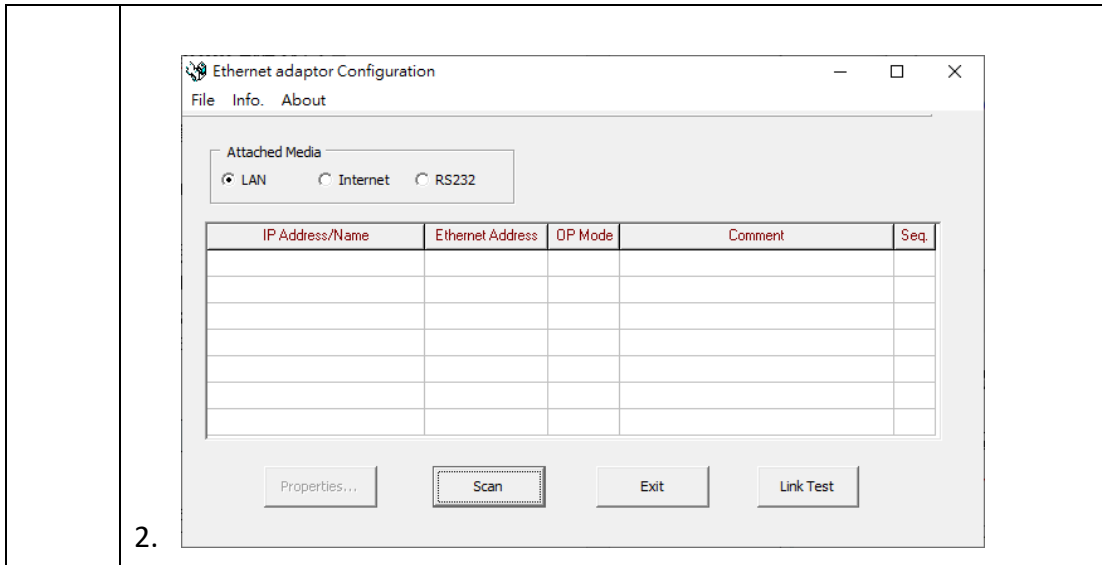

Confirm the software version first, or download the latest Ether_Config software directly from the FATEK website. After opening the software, pressing **Option->About** will show the version information:

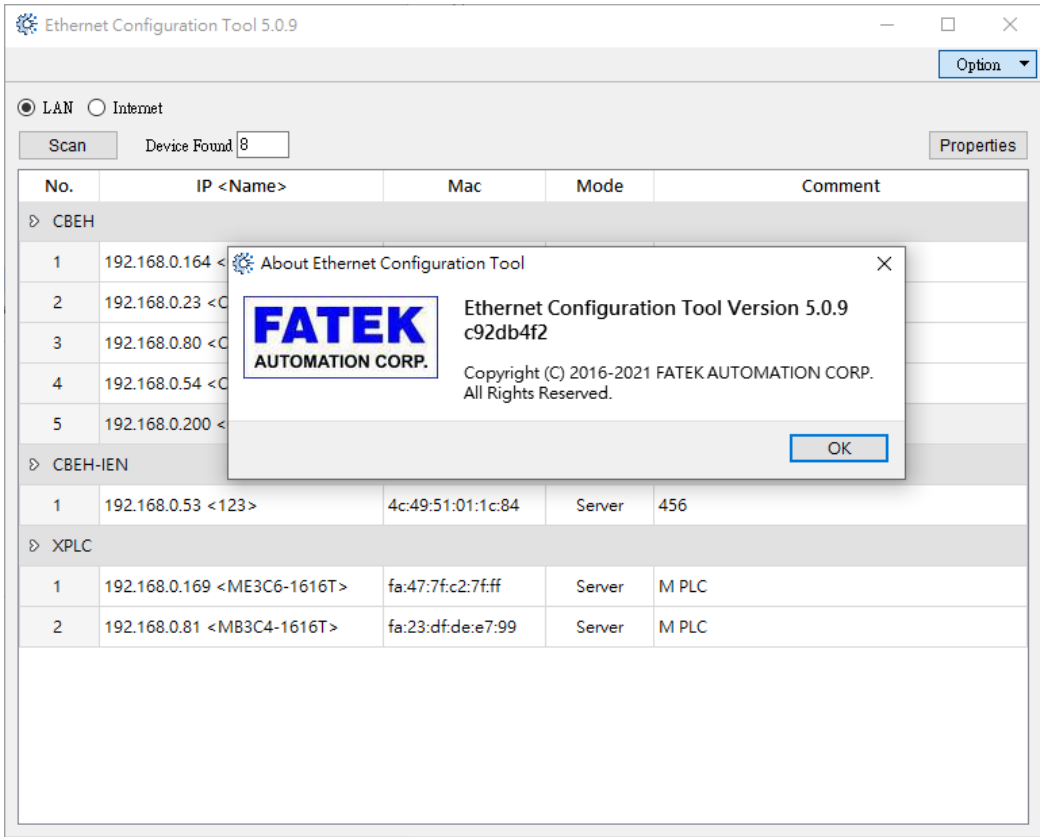

When the device has different network cards to choose from, you can switch on the software, press **Option->Select Network**:

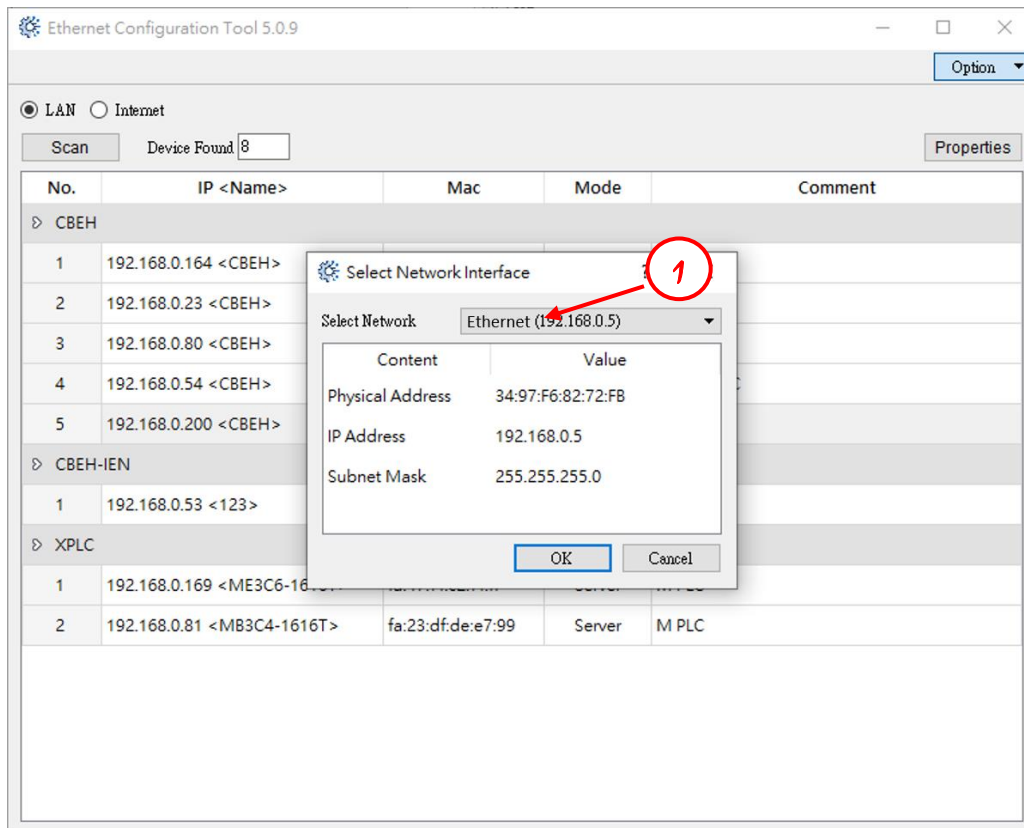

① Select the network interface card on the PC.

Because each user's network environment and other conditions are different, you can adjust the scan time and number of times and successfully search for modules in the domain. Click **Options -> Scan Setting**:

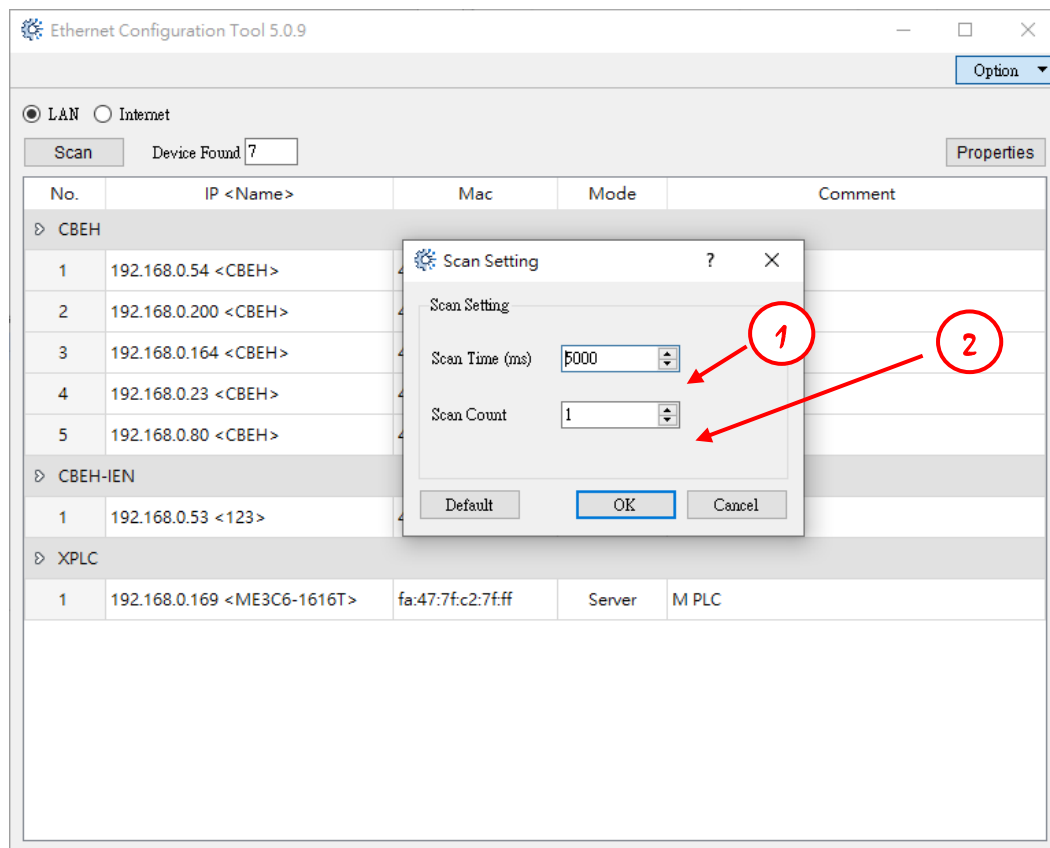

- ① The time of each scan, the default value is 5000, the unit is ms.
- ② Scan execution times, default value is 1

According to different languages and countries, three languages are provided for users to switch, click **Options->Language**

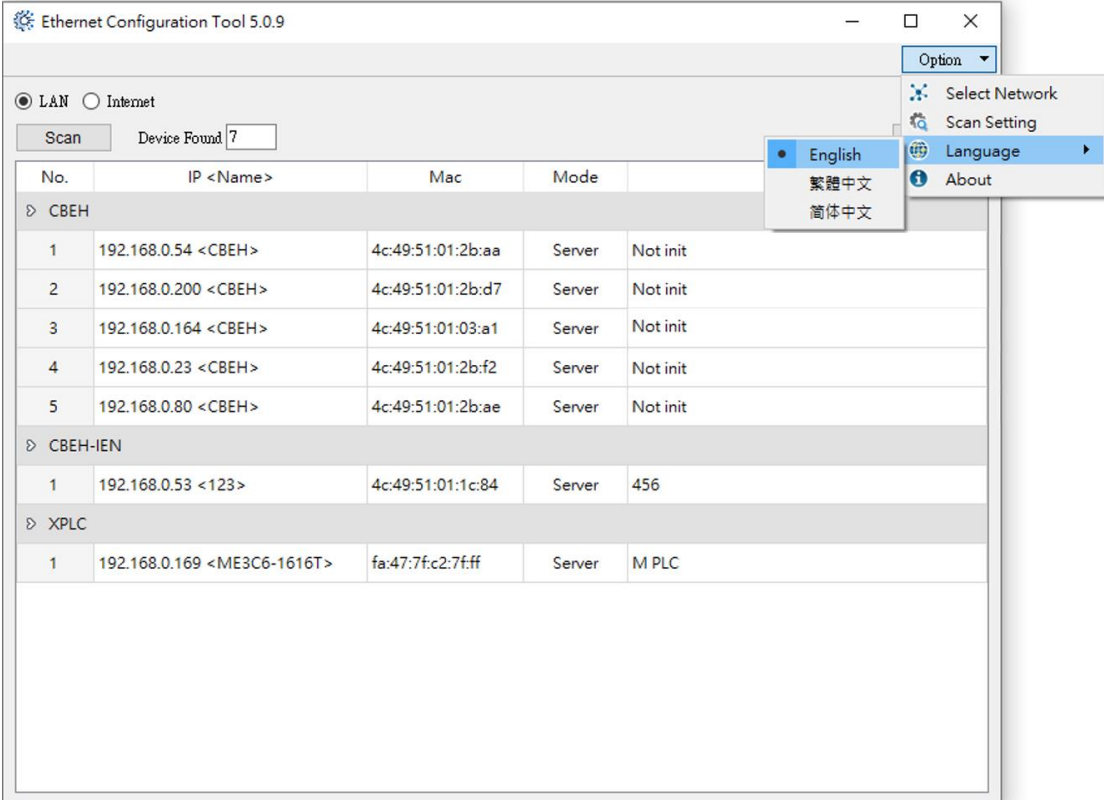

The screenshot shows the 'Ethernet Configuration Tool 5.0.9' window. At the top, there is a title bar with standard window controls and an 'Option' dropdown menu. Below the title bar, there are radio buttons for 'LAN' (selected) and 'Internet'. A 'Scan' button and a 'Device Found' field containing the number '7' are visible. The main area contains a table with columns: 'No.', 'IP <Name>', 'Mac', 'Mode', and an empty column. The table is organized into three sections: 'CBEH', 'CBEH-IEN', and 'XPLC'. The 'CBEH' section has 5 rows, 'CBEH-IEN' has 1 row, and 'XPLC' has 1 row. A context menu is open over the 'Option' dropdown, showing 'English' (selected), '繁體中文', and '简体中文'. Another menu is open over 'Language', showing 'Select Network', 'Scan Setting', 'Language' (with a right-pointing arrow), and 'About'.

No.	IP <Name>	Mac	Mode	
CBEH				
1	192.168.0.54 <CBEH>	4c:49:51:01:2b:aa	Server	Not init
2	192.168.0.200 <CBEH>	4c:49:51:01:2b:d7	Server	Not init
3	192.168.0.164 <CBEH>	4c:49:51:01:03:a1	Server	Not init
4	192.168.0.23 <CBEH>	4c:49:51:01:2b:f2	Server	Not init
5	192.168.0.80 <CBEH>	4c:49:51:01:2b:ae	Server	Not init
CBEH-IEN				
1	192.168.0.53 <123>	4c:49:51:01:1c:84	Server	456
XPLC				
1	192.168.0.169 <ME3C6-1616T>	fa:47:7f:c2:7f:ff	Server	M PLC

2.1.1 Use Local Area Network to Connect with Internet

When modules and personal computer (PC) are connected by local area network (LAN) but don't know the module IP address. Under this situation, users can execute Ether_Config software to connect to the communication modules through the following methods:

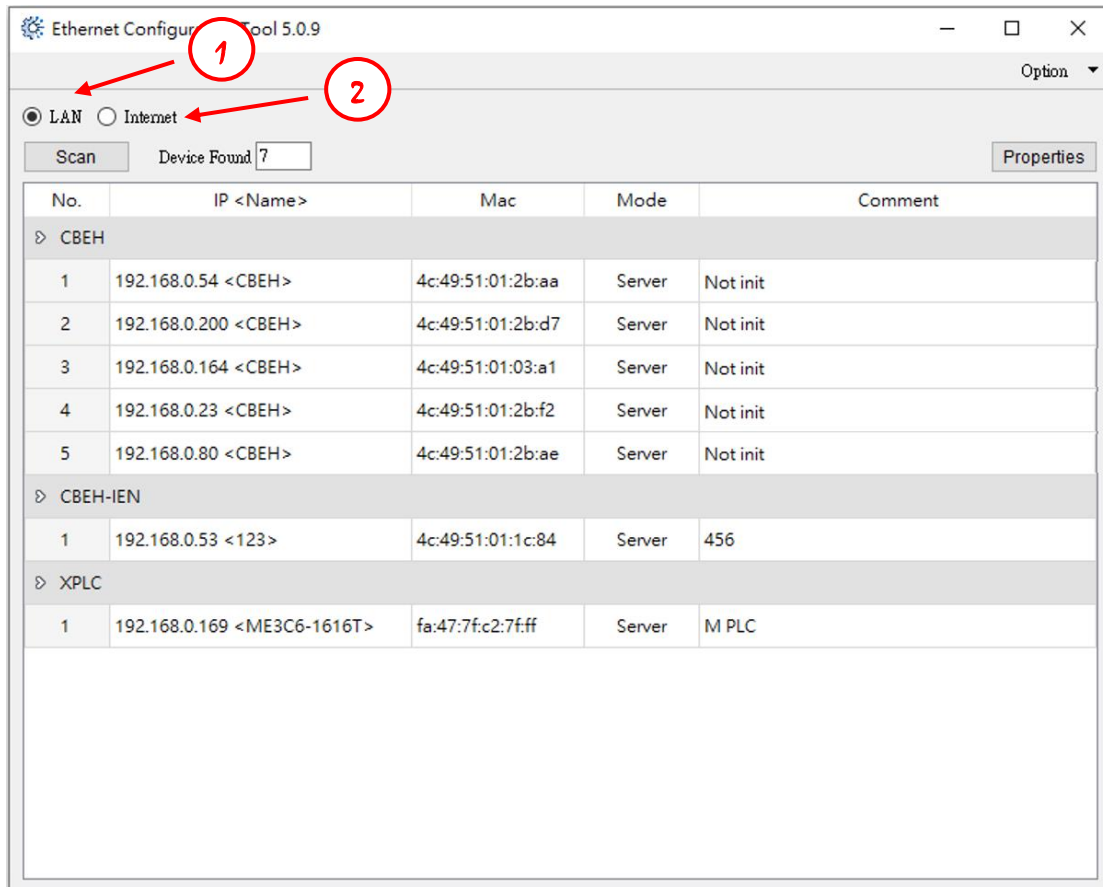

- ① Select **LAN**
- ② Click **Scan** button to scan the online network module, the table will list the scanned modules. After finish scanning, move the cursor to the module you want to set up, then click the left mouse button-> **Properties** or double click the left mouse button to enter the module configuration window.

If already know the IP address and its address is in the same domain, then follow the following method to connect the module:

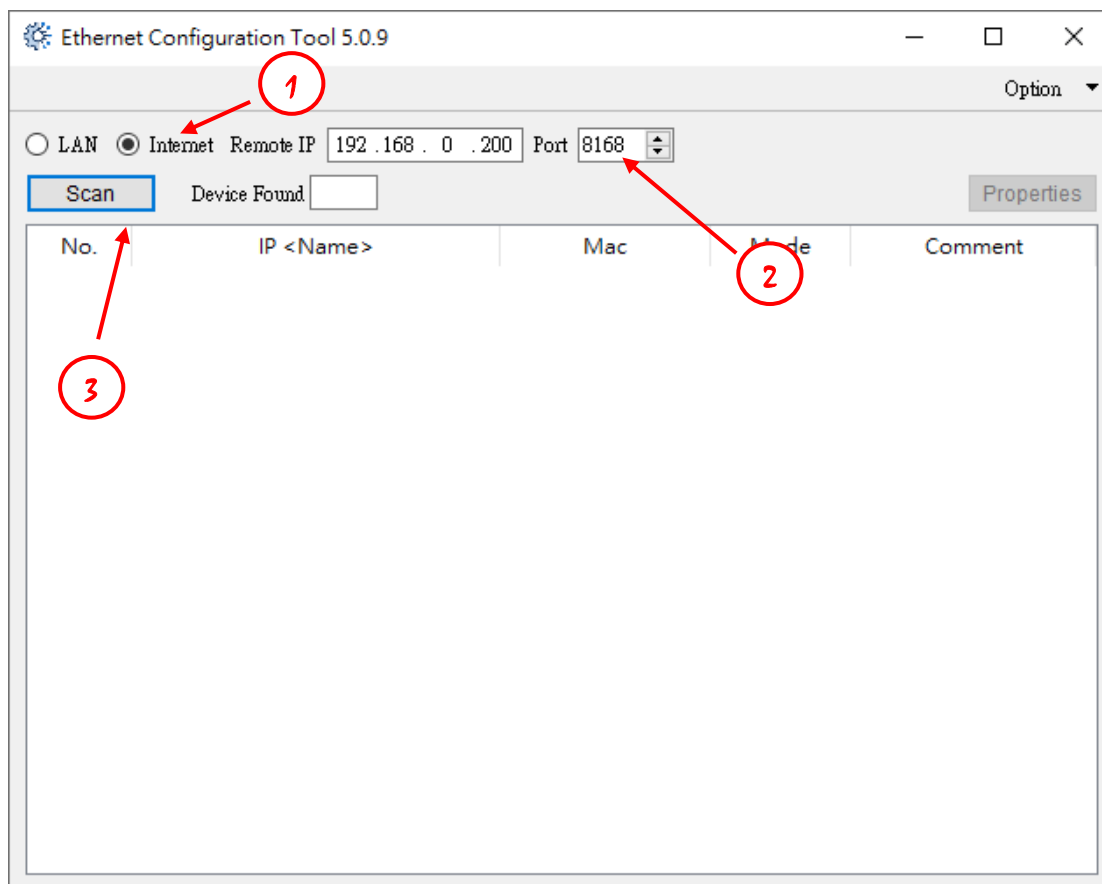

- ① Select **Internet**
- ② Enter module's IP address and communication port.
- ③ Click **Scan** button to scan the online network module, the table will list the scanned modules. After finish scanning, move the cursor to the module you want to set up, then click the left mouse button-> **Properties** or double click the left mouse button to enter the module configuration window.

Note	
	<p>1. If you want to use this method to connect a PC with modules, but they are in a different domain, then the Security-Remote Setting option need to be enabled (Please refer to chapter 2.1.2), because of different domains, additional port forwarding needs to be configured.</p> <p>2. If the module is behind the firewall, then need to open the firewall to do the remote configuration setting.</p> <p style="color: red;">FBs-CBES port number: 8168</p> <p style="color: red;">FBs-CBEH, FBs-CMEH, FBs-CM5EH port number: 111</p>

2.1.2 General Setting

Set the IP, mask and default gateway of the communication module

Parameter	Value
Hostname	CBEH
Comment	Not init
IP Setting	
IP Assign Mode	Static
IP Address	192.168.0.200
Subnet Mask	255.255.255.0
Gateway	192.168.0.1
Mac Address	4c:49:51:01:2b:d7
Firmware	
Firmware Version	CBEH 7.6
Firmware Upgrade	Upgrade

- **Hostname:** For comment use, can be used to identify different modules, up to 11 words can be input.
- **Comment:** For comment use, can be used to illustrate more detailed module information, up to 21 words can be entered.
- **IP Assign Mode:** Set according to application requirements, there are:
 1. **Static:** Assigned by static mode. Users need to set the network, mask and gateway address by themselves.
 2. **DHCP:** Assigned by dynamic mode. The user does not need to set the network, mask and gateway address, and dynamically obtains the usable address through the DHCP server.
 3. **By PLC:** The communication modules obtain the network address from the PLC register.
- **IP Address:** The network address of this communication module.
- **Subnet Mask:** The subnet mask of this communication module.
- **Gateway:** External gateway of this communication module.
- **Mac Address:** Unique hardware address.
- **Firmware Version:** Show current firmware version.
- **Firmware Upgrade:** For users to manually upgrade the firmware.

Note



Please note the following when upgrading the firmware:

1. Do not unplug the power supply at will during the upgrade.
2. If the upgrade operation is interrupted due to unknown factors, switch the power supply to restart the module and perform the upgrade operation again.
3. The firmware upgrade must execute under the same domain.

2.1.3 Security Setting

Avoid insecure connection entry through remote permissions and password settings.

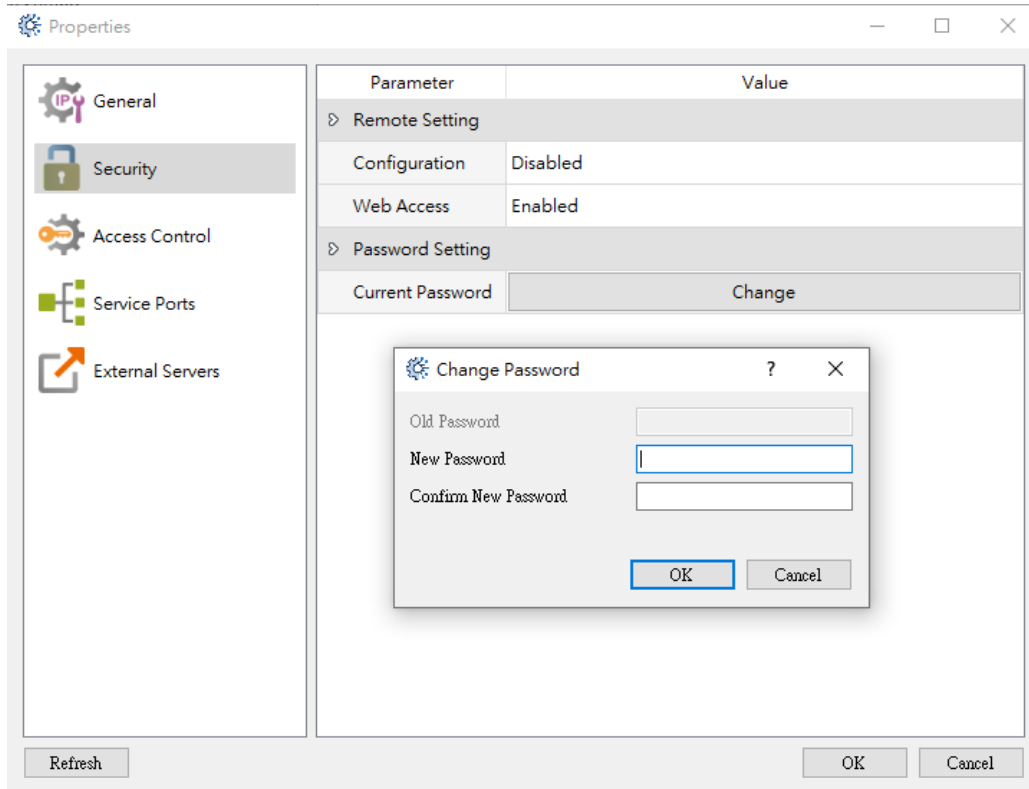

- **Remote Setting-Configuration:** When the remote is **enabled**, the Ether_Config settings can be executed through the Internet. If you want to use the Internet setting method mentioned above, you need to check this option. It is recommended that you use this method to set a password to avoid security vulnerabilities. If it is not necessary, do not **enable** this item to avoid improper connection.
- **Remote Setting-Web Access:** When **enabled**, it allows remote web page operations through the Internet. If you want to use the Internet setting method mentioned above, you need to check this option. It is recommended that you use this method to set a passcode to avoid security vulnerabilities. If it is not necessary, do not check this option to avoid improper modification.
- **Password Setting-Current Password:** User manually set password to protect it.

Note	
	1. Default factory password: 1234

2.1.4 Access Control Setting

Set grant IP to restrict unauthorized data access.

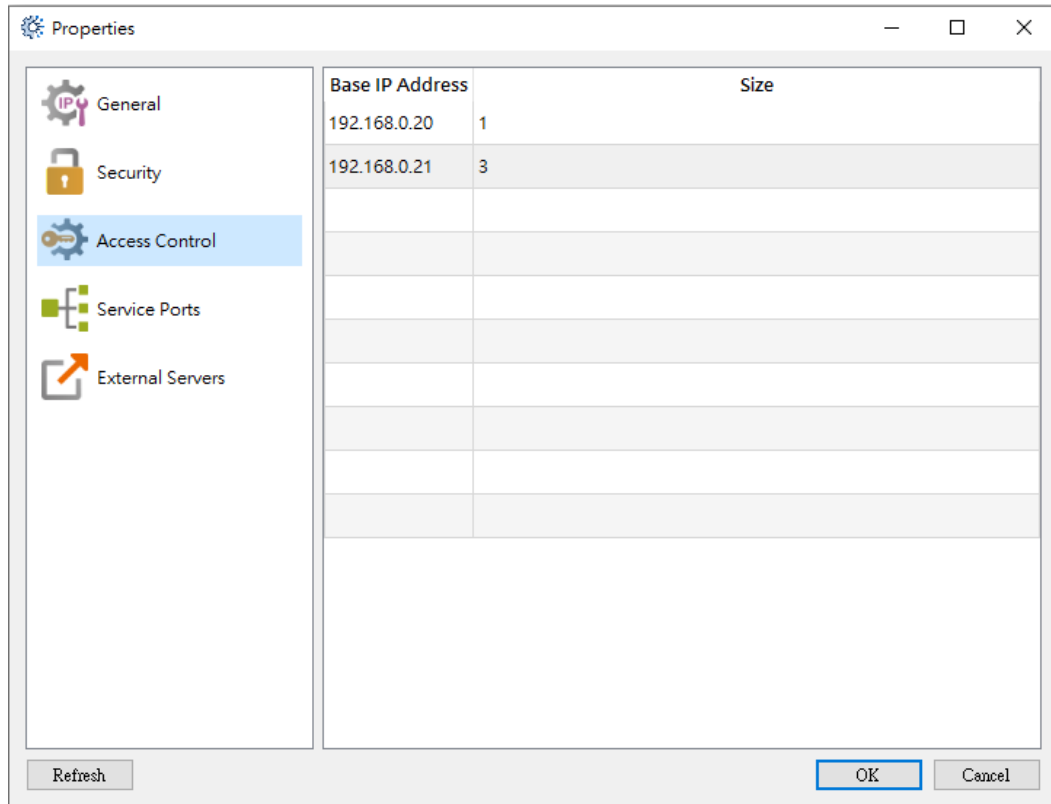

- **Base IP Address:** Show added IP list.
- **Size:** Display the number of consecutive IPs to be connected.

When setting, you can move the cursor to the table, click the right mouse button, and click **Add** to edit granted IP

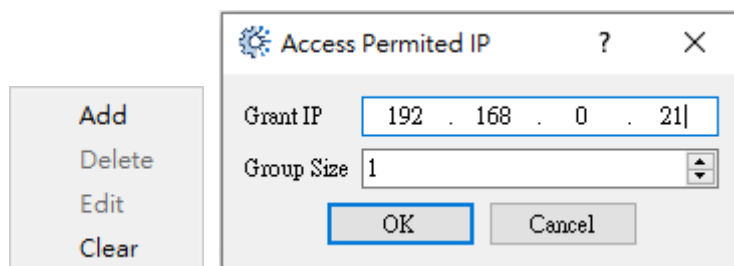

- **Add:** Add grant IP.
- **Delete:** Delete the selected IP.
- **Edit:** Edit the selected IP.
- **Clear:** Clear all IP on the list.
- **Grant IP:** Enter the IP location that is allowed to be accessed.
- **Group Size:** Enter the consecutive IP that are allowed to be accessed.

2.1.5 Service Ports Setting

Set the operation mode and protocol of the module

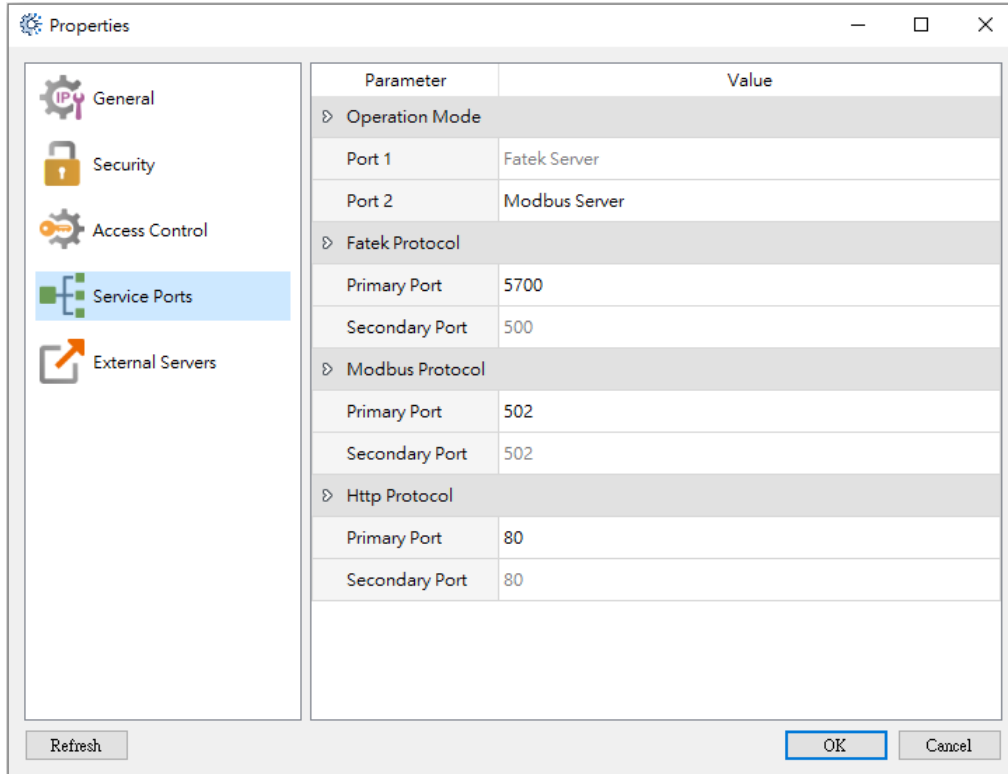

- **Operation Mode (Explain by FBs-CBEH):**
 1. Port 1 only supports Fatek server mode, and its operation mode can be used for ladder program editing and debugging or data access.
 2. Port 2 supports Fatek client mode, Modbus/TCP server mode, Modbus/TCP client mode, user server mode, and user client mode. When Port2 is selected to client mode, the user needs to configure port mapping settings on the **Port Mapping** page.
- **Fatek Protocol:** The main port number is for the user to modify, and the minor port number is forbidden to modify, the default is 500.
- **Modbus Protocol:** The main port number is for the user to modify, and the minor port number is forbidden to modify, the default is 502.
- **Http Protocol:** The main port number is for the user to modify, and the minor port number is forbidden to modify, the default is 80.

The following are the operation modes supported by each module

FBs-CBES															
<div style="border: 1px solid gray; padding: 5px;"> <div style="background-color: #f0f0f0; padding: 2px;">⤵ Operation Mode</div> <table border="1" style="width: 100%; border-collapse: collapse;"> <tr> <td style="width: 20%;">Port 1</td> <td>Fatek Server</td> </tr> <tr> <td>Port 2</td> <td>Modbus Server ▼</td> </tr> <tr> <td colspan="2"> <div style="background-color: #0070c0; color: white; padding: 2px;">Fatek Client</div> </td> </tr> <tr> <td>⤵ Fatek Protocol</td> <td>Modbus Server</td> </tr> </table> </div>		Port 1	Fatek Server	Port 2	Modbus Server ▼	<div style="background-color: #0070c0; color: white; padding: 2px;">Fatek Client</div>		⤵ Fatek Protocol	Modbus Server						
Port 1	Fatek Server														
Port 2	Modbus Server ▼														
<div style="background-color: #0070c0; color: white; padding: 2px;">Fatek Client</div>															
⤵ Fatek Protocol	Modbus Server														
FBs-CBEH															
<div style="border: 1px solid gray; padding: 5px;"> <div style="background-color: #f0f0f0; padding: 2px;">⤵ Operation Mode</div> <table border="1" style="width: 100%; border-collapse: collapse;"> <tr> <td style="width: 20%;">Port 1</td> <td>Fatek Server</td> </tr> <tr> <td>Port 2</td> <td>Modbus Server ▼</td> </tr> <tr> <td colspan="2"> <div style="background-color: #0070c0; color: white; padding: 2px;">Fatek Client</div> </td> </tr> <tr> <td>⤵ Fatek Protocol</td> <td>Modbus Server</td> </tr> <tr> <td>Primary Port</td> <td>Modbus Client</td> </tr> <tr> <td>Secondary Port</td> <td>User Server</td> </tr> <tr> <td></td> <td>User Client</td> </tr> </table> </div>		Port 1	Fatek Server	Port 2	Modbus Server ▼	<div style="background-color: #0070c0; color: white; padding: 2px;">Fatek Client</div>		⤵ Fatek Protocol	Modbus Server	Primary Port	Modbus Client	Secondary Port	User Server		User Client
Port 1	Fatek Server														
Port 2	Modbus Server ▼														
<div style="background-color: #0070c0; color: white; padding: 2px;">Fatek Client</div>															
⤵ Fatek Protocol	Modbus Server														
Primary Port	Modbus Client														
Secondary Port	User Server														
	User Client														
FBs-CMEH															
<div style="border: 1px solid gray; padding: 5px;"> <div style="background-color: #f0f0f0; padding: 2px;">⤵ Operation Mode</div> <table border="1" style="width: 100%; border-collapse: collapse;"> <tr> <td style="width: 20%;">Port 3</td> <td>Fatek Server</td> </tr> <tr> <td>Port 4</td> <td>Modbus Server ▼</td> </tr> <tr> <td colspan="2"> <div style="background-color: #0070c0; color: white; padding: 2px;">Fatek Client</div> </td> </tr> <tr> <td>⤵ Fatek Protocol</td> <td>Modbus Server</td> </tr> <tr> <td>Primary Port</td> <td>Modbus Client</td> </tr> <tr> <td>Secondary Port</td> <td>User Server</td> </tr> <tr> <td></td> <td>User Client</td> </tr> </table> </div>		Port 3	Fatek Server	Port 4	Modbus Server ▼	<div style="background-color: #0070c0; color: white; padding: 2px;">Fatek Client</div>		⤵ Fatek Protocol	Modbus Server	Primary Port	Modbus Client	Secondary Port	User Server		User Client
Port 3	Fatek Server														
Port 4	Modbus Server ▼														
<div style="background-color: #0070c0; color: white; padding: 2px;">Fatek Client</div>															
⤵ Fatek Protocol	Modbus Server														
Primary Port	Modbus Client														
Secondary Port	User Server														
	User Client														
FBs-CM5EH															
<div style="border: 1px solid gray; padding: 5px;"> <div style="background-color: #f0f0f0; padding: 2px;">⤵ Operation Mode</div> <table border="1" style="width: 100%; border-collapse: collapse;"> <tr> <td style="width: 20%;">Baud Rate</td> <td>9600</td> </tr> <tr> <td>Port 4</td> <td>Fatek Server ▼</td> </tr> <tr> <td colspan="2"> <div style="background-color: #0070c0; color: white; padding: 2px;">Fatek Server</div> </td> </tr> <tr> <td>⤵ Fatek Protocol</td> <td>Modbus Server</td> </tr> </table> </div>		Baud Rate	9600	Port 4	Fatek Server ▼	<div style="background-color: #0070c0; color: white; padding: 2px;">Fatek Server</div>		⤵ Fatek Protocol	Modbus Server						
Baud Rate	9600														
Port 4	Fatek Server ▼														
<div style="background-color: #0070c0; color: white; padding: 2px;">Fatek Server</div>															
⤵ Fatek Protocol	Modbus Server														

Note	
	<ol style="list-style-type: none"> 1. Http protocol only support FBs-CBEH, FBs-CMEH, and FBs-CM5EH. 2. FBs-CM5EH provides Port 4 which can support up to 307200bps.

Consecutive IP No.: The content will be set with continuous IP and fixed station number.

Group Mode		Consecutive IP No.			
Local Station	Remote IP	Remote Station	Remote Port	Group Size	
1~3	192.168.0.212~214	1	500	3	

When setting, you can move the cursor to the table, click the right mouse button, and click **Add** to edit grant IP.

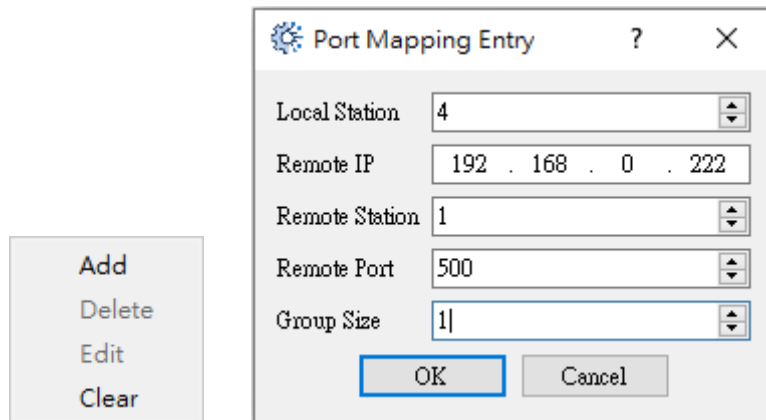

- **Add:** Add IP to correspond.
- **Delete:** Delete the currently selected IP corresponding data.
- **Edit:** Edit the currently selected IP corresponding data.
- **Clear:** Delete all IP corresponding data on the list.
- **Local Station:** Represents the representative station number of the remote PLC at the local end.
- **Remote IP:** The IP of the module to which the remote PLC belongs on the network.
- **Remote Station:** The actual station number of the remote PLC on the network.
- **Remote Port:** The port number of the module that the remote PLC belongs to.
- **Group Size:** When the mode is set to **Consecutive Station No.**, this setting can define a group of station number comparison at a time. For example, if you want to set the local station number 10~19 to correspond to the remote station number 20~29 and the remote IP is 192.168.1.102, you can set the local Station number=10, remote IP=192.168.1.102, remote station number=20, quantity=10, remote port number is generally set to 500. Up to 18 groups can be set internally for the station number and IP correspondence setting. When the mode is set to **Consecutive IP No.**, this setting can define a group of IP controls at a time.

Note



1. Configure two groups of Fatek network modules for active and passive connection

Network module 1 (Fatek client mode), need to set the PLC Fun151 communication command (for detailed settings, refer to the PLC manual) to communicate with network module 2 (Fatek servo mode). Module 1 sets the communication command table in Fun151, the slave station number must be the same as the local station number in the station number and IP corresponding setting, and the remote IP is the network module 2 for connection.

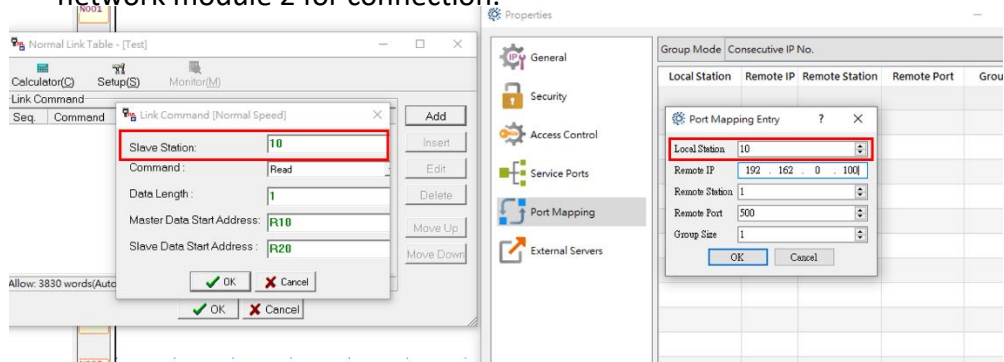

2. When the remote station number uses FBs-CM25E, FBs-CM55E in client mode, it will be used. Please refer to the manual for details.

<https://www.fatek.com/en/download.php?act=list&cid=60>

Ethernet Module User's Manual(CM25E/CM55E/CBE)

2.1.7 External Servers Setting

Some modules provide functions of several external servers.

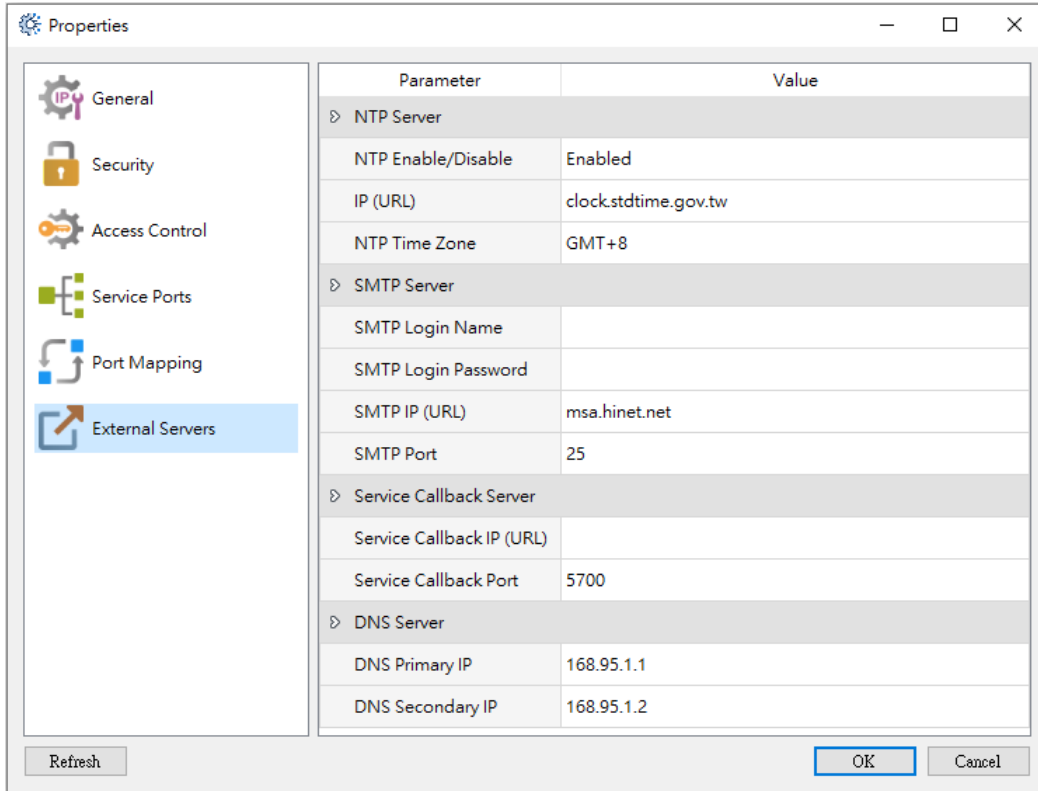

- **NTP Server:** Provides the function of automatic network time adjustment, which can avoid the trouble of manually adjusting the time on a regular basis. To enable the service, tick the Enable box. After the service is enabled, the latest time information will be obtained from the NTP Calendar register (D3953~D3960) (for details, please refer to Chapter 3.3).
 1. Enable/Disable: Turn on or off the NTP function.
 2. IP (URL): For the URL of the NTP server, please refer to the Internet time server URL in the user's operating system.
 3. NTP Time Zone: The time zone setting of the location of the application, the picture above is Taipei GMT+08:00, which means that the time zone of Taipei is Greenwich Mean Time + 8 hours.
- **SMTP Server:** Delete the currently selected IP corresponding data.
 1. SMTP Login Name: SMTP Server account.
 2. SMTP Login Password: SMTP Server password.
 3. SMTP IP (URL): Outgoing server IP.
 4. SMTP Port: Default HiNet external server port number 25.
- **Service Callback Server:** Provide automatic maintenance callback function. To use this function, you must first fill in the network IP and port number where the callback server is located.

- **DNS Server:** Domain Name Server. When the IP address of an external server is entered in the form of a domain name, an external domain name query service will be used. To use the service, you need to fill in the following fields first. You can refer to the primary DNS and secondary DNS fields in the network function settings of the Windows operating system to set. If the IP acquisition mode is set to dynamic (DHCP) acquisition mode, no setting is required. The main DNS setting shown in the figure below is the DNS server address of Chunghwa Telecom.

Note	
	Nowadays, most of the sending and receiving of emails through the SMTP protocol are achieved through encryption. The FATEK network module series does not yet support encryption. Therefore, if users want to use this function, they must first confirm whether the server supports no encryption.

2.1.8 IoT Service

iMonitor, iLocation function enable and related settings

The screenshot shows a 'Properties' dialog box with a sidebar on the left containing icons for General, Security, Access Control, Service Ports, External Servers, and IoT Service. The IoT Service tab is selected. The main area contains a table with the following parameters and values:

Parameter	Value
HWID	66A [blurred]
iMonitor Status	Connecting
iMonitor	
Enable/Disable	Enabled
Server	fatekcloud.net
Password	●●●
iLocation	
Enable/Disable	Enabled
Type	Static
GPS Format	dddDDDDDDD (DD)
Latitude	N 0.0000000°
Longitude	E 0.0000000°

At the bottom of the dialog, there are 'Refresh', 'OK', and 'Cancel' buttons.

- **HWID:** The factory will give every device a unique hardware ID.
- **iMonitor Status:** iMonitor service status.
- **iMonitor Enable/Disable:** Enable iMonitor service or not.
- **iMonitor Server:** Select the applied server.
- **iMonitor Password:** Password for the iMonitor service.
- **iLocation Enable/Disable:** Enable iLocation service or not.
- **iLocation Type:** Set the GPS type.
- **iLocation GPS Format:** Set the GPS display format.
- **iLocation Latitude:** For users to use when is under static mode.
- **iLocation Longitude:** For users to use when is under static mode.

Note	
	1. To enable iMonitor connection, you need to create a new device on the Web first

2.2 Setting Through Web Browser (not all modules supported)

When the user already knows the module IP address, and that address matches the actual connecting domain section (for example if the actual domain section is 192.168.2.X and the expansion board's network address is 192.168.2.5), then web browsers can be used to enter the webpage provided by the expansion board to perform configuration settings (of course the PC must also be able to connect to that domain section). Open the web browser and enter the IP address in the web address column to get the login web page. As shown in the example below, when the IP address to be connected is 192.168.2.32, then in the web browser, enter:

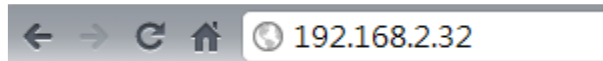

If the IP is correct then the login page will be shown as follow

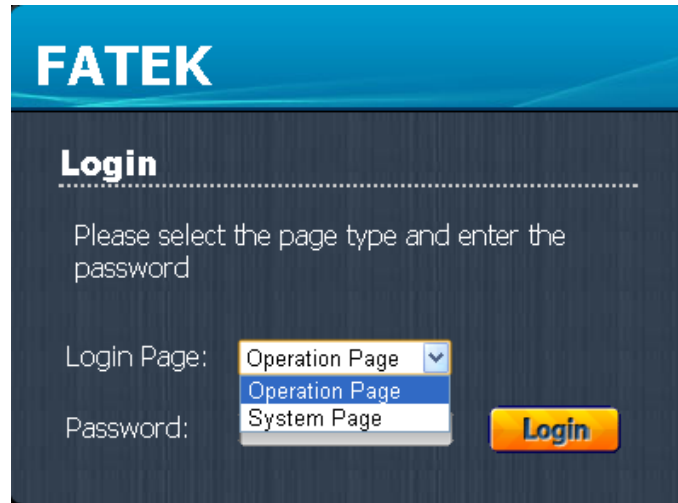

Note	
	<ol style="list-style-type: none">1. Default factory password: 12342. Only supports FBs-CBEH, FBs-CMEH, FBs-CM5EH

2.2.1 System Page

The system page provides related setting and control for basic configuration, external services, and real-time monitoring etc. for the user; the user can understand the entire system page's environment and architecture from the figure below.

➤ The operation sequence of the system page is:

I. Select the item to set from the function menu.

II. Complete the setting to modify in the function setting page.

III. Click the **Apply** button to apply the settings.

IV. Click the **Update Settings To PLC** button to update the applied settings.

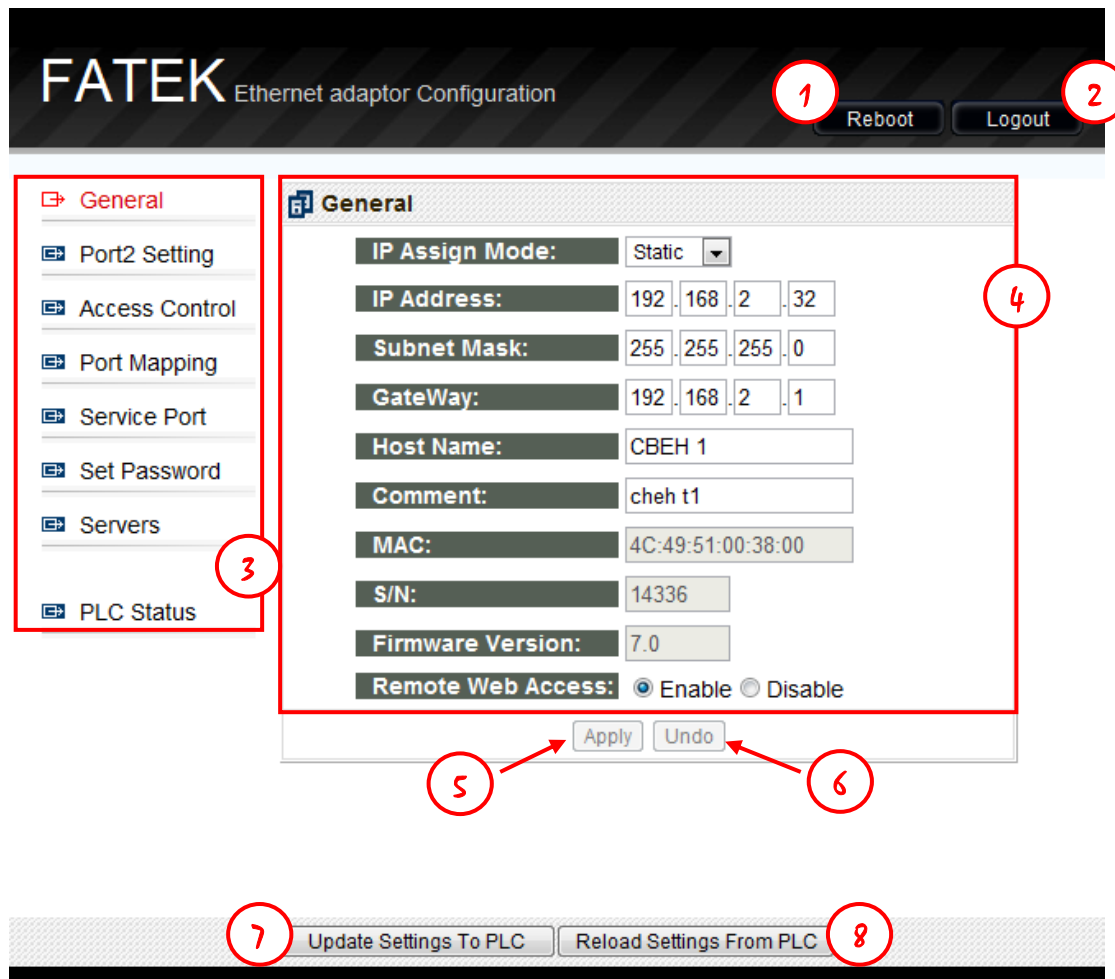

① **Reboot** Reboots the system.

② **Logout** Logs out of the system page.

③ Function menu.

④ Function setting page.

- ⑤ **Apply** applies the currently modified contents to this page, but this modification is not yet updated to the module.
- ⑥ **Undo** Restore the most recently applied settings.
- ⑦ **Update Settings To PLC** Updates all of the modified content onto the module.
- ⑧ **Reload Settings From PLC** Discard the edited content and read the setting again.

2.2.2 General Setting

Common data setting: Set the module's network address, mask and gateway parameters. To set these parameters click the General setting page, and the following screen will appear:

The screenshot shows a web form titled "General" with the following fields and values:

- IP Assign Mode:** Static (dropdown menu)
- IP Address:** 192 . 168 . 2 . 32
- Subnet Mask:** 255 . 255 . 255 . 0
- GateWay:** 192 . 168 . 2 . 1
- Host Name:** CBEH 1
- Comment:** ch eh t1
- MAC:** 4C:49:51:00:38:00
- S/N:** 14336
- Firmware Version:** 7.0
- Remote Web Access:** Enable Disable

At the bottom of the form are two buttons: "Apply" and "Undo".

The following describes the meaning of each field:

- **IP Assign Mode:** IP acquisition mode. Users can set according to their application needs, there are:
 1. Static: Static acquisition. User needs to manually set the network, mask and gateway address.
 2. DHCP: Dynamic acquisition. User does not need to set the network, mask and gateway address; usable address will be acquired from the DHCP server.
 3. By PLC: Obtained from the PLC's register.
- **IP Address:** The IP address in the network.
- **Subnet Mask:** The subnet mask for identifying the domain.
- **GateWay:** The gateway of the domain where the module is located.
- **Host Name:** Used for commenting, able to identify different modules; a maximum of 11 characters can be entered.
- **Comment:** Used for commenting; used to explain detailed module information, a maximum of 21 characters can be entered.
- **MAC:** The MAC Address of this expansion board.

- **S/N:** The manufacturing serial number. The module can use this serial number to directly connect to the web page. Using serial number 14336 in the figure above as a usage example, in the browser web address column enter: `http://fac14336` to connect to the web page. This method can only be used under the local area network (LAN) connection.
- **Firmware Version:** Displays the expansion board's firmware version.
- **Remote Web Access:** Security setting. When checked, it allows remote web page setting through the internet. This item must be checked if you want to use the internet setting method mentioned above.

Note	
	It is suggested to use the password protection when Remote Web Access is checked in order to avoid security leakages. Please do not check this option if not necessary in order to avoid malicious access.

2.2.3 Operation Mode Setting

Network module use Port1/Port3 for the Fatek Server and Port2/Port4 for Modbus/TCP or Fatek client mode. For configuration, click on the Port2/4 setting page and you will see the following screen:

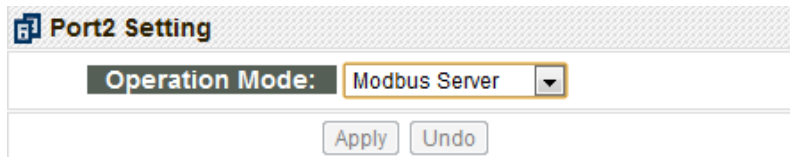

Click the combo list box behind Operation Mode to select one of the following operation modes:

1. Fatek Client
2. Modbus Server
3. Modbus Client

When Port2 is selected to Modbus client mode or Fatek client mode, the user must perform settings in the Port Mapping setting page. Select according to the user's need and then click the Apply button to complete the setting.

FBs-CM5EH uses Port 4 (RS485, network) and the PLC. Click the combo list box behind Operation Mode to select one of the following operation modes:

1. Fatek Server
2. Modbus Server

For configuration, click on the Port4 setting page and you will see the following screen:

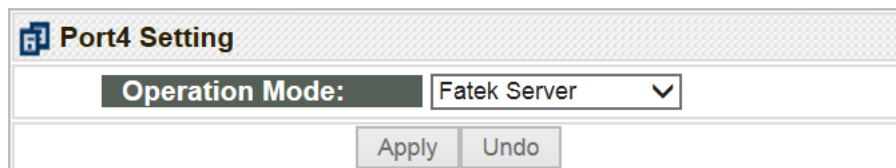

2.2.4 Access Control Setting

Access control: Set authorized network address to restrict inappropriate data accessing. To set authorized network address you can click the Access Control setting page and the following screen will appear:

New / Edit - Grant IP

Grant IP: . . .

Group Size:



Grant IP List

Base IP Address	size
-----------------	------

When setting is required, you can fill in the authorization data in the New/Edit-Grant IP field; in the Grant IP field, enter the smallest IP address, and in the Group Size field, enter the number of IPs; click the Add button when completed. To modify or delete an authorization data, click the icons behind the Grant IP List field to perform the operations:

Grant IP List

Base IP Address	size
192.168.2.1	20

The  icon is to modify; when pressed, it will change to the  icon, and the highlighted parts will turn red, then you can modify above the field and then press Apply to complete the modification. To delete an authorization data, click the  icon directly to delete it.

2.2.5 Port Mapping

When the operation mode in the basic settings page is set as Modbus/Fatek client mode, an extra port mapping page will appear. The following screen will appear after clicking it with the mouse:

New / Edit - Port Mapping

Local Station:

Remote Station:

Remote IP: . . .

Remote Port:

Group Size: IP Station

Port Mapping List

Local Station	Remote			
	IP Address	Station	Port	Size



When setting is required, users can enter the mapping data in the New/Edit-Port Mapping fields. The following is the meaning of each field:

- **Local Station:** Represents the remote PLC's designated station number at the local end.
- **Remote Station:** Represents the actual station number of the mapping network remote PLC.
- **Remote IP:** The IP address of the remote PLC.
- **Remote Port:** The IP port number of the remote PLC.
- **Group Size:** A group of station numbers mapping can be defined every time for this setting; for example, if you want to set the local station numbers 10~19 to map the remote station numbers 20~29, and the remote IP is 192.168.1.3, you can set Local Station=10, Remote Station=20, Group Size=10, Remote IP=192.168.1.3, the Remote Port is generally set to 500. A maximum of 18 group mapping can be set.
- **IP:** Consecutive network addresses. When the Group Size is specified, its contents will be a consecutive network address and a fixed station number configuration, as shown in the figure below:

Port Mapping List



Local Station	Remote			
	IP Address	Station	Port	Size
1	192.168.2.1~	1	1	3



- **Station:** Consecutive station number. When the Group Size is specified ^{Note*1}, its content will be a fixed network address and consecutive station number configuration, as shown in the figure below:

Local		Remote				
Station	IP Address	Station	Port	Size		
1	192.168.2.1	1~	1	3		

Note*1: The Group's IP or Station radio button setting is a global setting; it cannot be set entry by entry.

To modify or delete a mapping data, you can press the icons behind the Port Mapping List field to operate:

Local		Remote				
Station	IP Address	Station	Port	Size		
1	192.168.2.1	1	500	1		

The  icon is to modify; when pressed, it will change to the  icon, and the highlighted parts will turn red, then you can modify above the field and then press Apply to complete the modification. To delete an authorization data, click the  icon directly to delete it.

2.2.6 Service Ports

The service ports must first be set before the server function of the module can operate; the external client-ends will use this service port to send connection requests to the module and so the messages can be received.

The default FATEK communication protocol service port is 500, Modbus' communication protocol service port is 502, Http communication protocol service port is 80. A maximum of 2 service port numbers can be provided to each service at the same time, in which one is a fixed default port and the other is a modifiable port.

If the user wants to modify the modifiable service port, the Service Ports setting page can be used to make the modification. While modifying, just enter the port number you want to modify into the Major Port field.

Fatek Protocol	
Major Port:	500
Secondary Port:	500
Modbus Protocol	
Major Port:	502
Secondary Port:	502
Http Protocol	
Major Port:	80
Secondary Port:	80
<input type="button" value="Apply"/> <input type="button" value="Undo"/>	

2.2.7 Security Setting

Password protection: To set the password, click the Set Password setting page, and the following window will appear:

The image shows two sections for setting passwords. The first section is titled 'User - Set New Password' and contains two input fields: 'New Password:' and 'Confirm:', both with seven dots. The second section is titled 'System - Set New Password' and also contains two input fields: 'New Password:' and 'Confirm:', both with seven dots. A 'Set' button is located at the bottom right of the System section.

According to operation privilege differences, this product series divides the password section into User password and System password. To enter an operation page, the user password or system password must be entered in order to log in; and to enter the system webpage, the system password must be entered to log in. There is no password set for the default factory user password, and the default factory system password is 1234.

If modification to the user or system webpage password is required, you can check the box in the page and enter the same password twice and then press the Set button to complete the modification:

The image shows the 'System - Set New Password' section with a checked checkbox. The 'New Password:' and 'Confirm:' input fields both contain four dots. A 'Set' button is located at the bottom right.

Note



1. The default operation password is none.
2. The default system password is 1234.

2.2.8 External Servers

This product series provides some functions that require external services; to use these functions, click the “External Servers” setting page, and the following screen will appear:

External Servers

DNS Server 1: 168 .95 .192 .1

DNS Server 2: 168 .95 .1 .1

NTP IP(URL): clock.stdtime.gov.tw

Time Zone: GTM +8:00

SVC IP(URL):

SVC Port: 5700

SMTP Server: mail.petekteknoji.com.tr

SMTP Login ID: berkengin@petekteknoji.cc

SMTP Login PW: berk123

Apply Undo

DNS Server: Domain name service server. Just like the primary DNS and secondary DNS set on the PC. This setting is not necessary if the network address setting is set to the dynamic (DHCP) mode. The preferred DNS setting in the figure below is the DNS server address of Chunghwa Telecommunications:

DNS Server 1: 168 .95 .1 .1

DNS Server 2: 168 .95 .1 .2

- **DNS Server 1:** IP address of primary DNS Server.
- **DNS Server 2:** IP address of secondary DNS Server.

NTP Server: It provides the internet clock synchronization function, eliminating the trouble of manually correcting the time on a regular basis. To enable this service, just check the box and enter the NTP server address; when the service is enabled, the synchronization time data can be queried from the NTP Calendar register (D3953~D3960) (Please refer to Chapter 3.3.2 for details).

NTP IP(URL): time-a.nist.gov

Time Zone: GTM +8:00

- **NTP IP (URL):** The IP address or domain name of the NTP server. There are many NTP servers all over the world. The easiest way to get the IP address of NTP server

is to refer the setting of PC.

- **Time Zone:** Time zone configuration; the example above uses Taipei GMT + 08:00, which means that the time zone of Taipei is Greenwich Standard Time + 8 hours.

Service Call Back Server: It provides the automatic service callback server function; to use this function, the user must first fill in the network address and port number of the maintenance center:

SVC IP(URL):	<input type="text" value="192.168.2.19"/>
SVC Port:	<input type="text" value="5700"/>

- **SVC IP(URL):** Service center's network address or domain name address
- **SVC Port:** Service center port number.

SMTP Server: It provides Email sending function; to use this function, just enter the send server's IP address or domain name into the SMTP Server field:

SMTP Server:	<input type="text" value="msa.hinet.net"/>
SMTP Login ID:	<input type="text" value="fatektest"/>
SMTP Login PW:	<input type="text" value="123456"/>

- **SMTP Server:** Outgoing Email server IP address or domain name.
- **SMTP Login_ID:** SMTP Server Account.
- **SMTP Login_PW:** SMTP Server Password.

Note	
	1. Nowadays, most of the sending and receiving of emails through the SMTP protocol are achieved through encryption mechanisms. The FATEK network module series does not yet support encryption mechanisms. Therefore, if users want to use this function, they must first confirm whether the server supports no encryption.

Chapter 3. Advanced Setting

3.1 Customize Page Design

This product series provides the web server function, in addition to the system webpage, it also allows users to create own customized webpage to easily browse or control the status within the PLC. In order to help the user to create their own web page without knowing the web page authoring language -HTML, a convenient software –“Easy Web Designer” is provided. Below we will introduce how to complete a customized webpage by using this software.

Note	
	<p>The functions supported by each module are as follows:</p> <ol style="list-style-type: none">1. Customized web page design: FBs-CBEH, FBs-CMEH, FBs-CM5EH2. Email sending, email to SMS: FBs-CBEH, FBs-CMEH, FBs-CM5EH3. NTP: FBs-CBEH, FBs-CMEH, FBs-CM5EH4. System webpage monitoring PLC internal status: FBs-CBEH, FBs-CMEH, FBs-CM5EH5. Active callback: FBs-CBEH, FBs-CMEH, FBs-CM5EH6. FATEK IoT Service (iMonitor, iLocation): FBs-CBES

3.1.1 Change Page Layout

The changing of webpage style is mainly to customize the login page for different languages (locale). The styles include displayed font style of the web page, the company name, web page title, description string of the login page and login error hint messages etc., these changes can be made by using the “Easy Web Designer” software.

Login page style

The webpage login page is as shown in the figure below; the indicators specified in the figure are parts where the style can be changed.

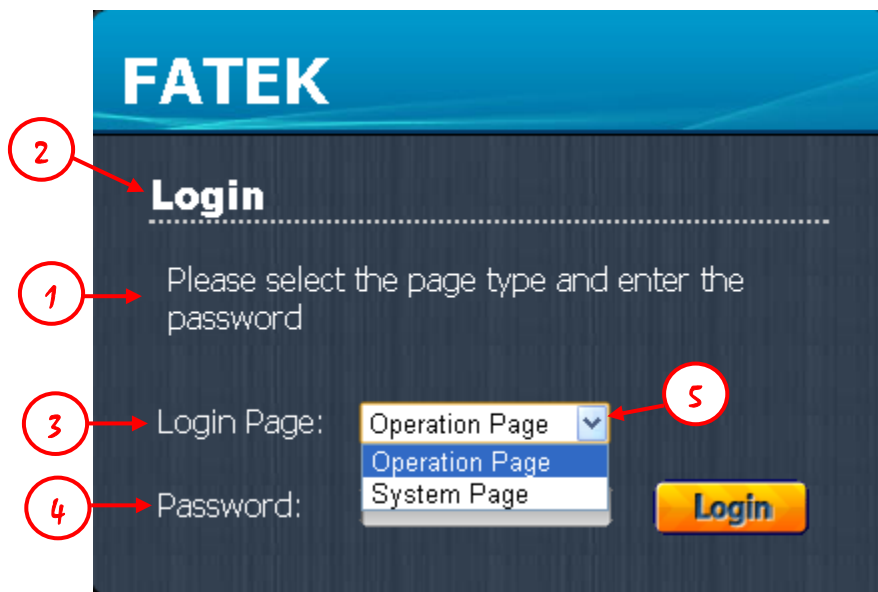

- ① Webpage title: The operation description text of the login screen.
- ② Company title: The title text displayed on top of the login screen.
- ③ Page selection title: The title text displayed on the login screen in front of the page selection item.
- ④ Password title: The title text displayed on the login screen in front of the password input box.
- ⑤ Operation page string: The selection string displayed on the login screen when the selected item is operation page.

System page string: The selection string displayed on the login screen when the selected item is system page.

If you want to change the setting described above, please follow the following steps to perform the setting:

Step 1, open Easy Web Designer, and double click on “Page Style Setting” on the created project.

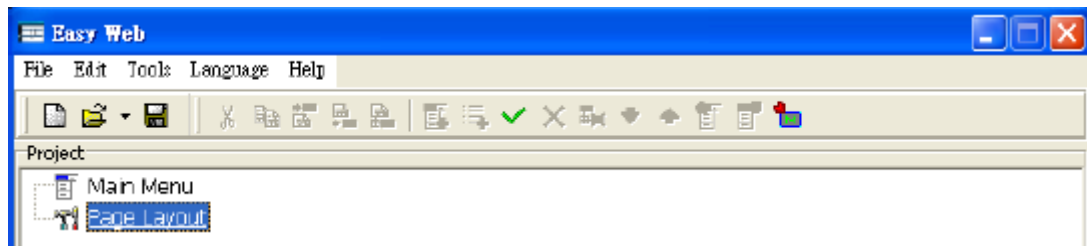

Step 2, after double clicking, the style setting window will appear, click the “login page” tab to perform setting; detailed description of each field are as follows.

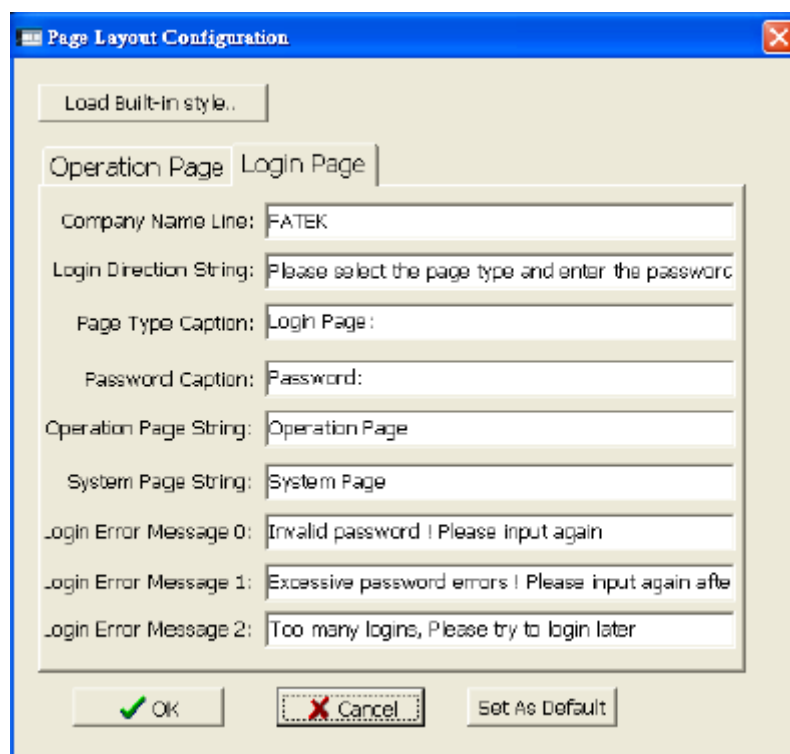

- Page title: The operation description text on the login screen.
- Company title: The title text displayed on top of the login screen.
- Page selection title: The title text displayed on the login screen before the page selection item.
- Password title: The title text displayed on the login screen in front of the password input box.
- Operating page string: The selection string displayed on the login screen when the selected item is operation page.
- System page string: The selection string displayed on the login screen when the selected item is system page.

- Login error message 0: The message displayed in the dialog box when there is a login error.
- Login error message 1: The message displayed in the dialog box when the wrong password has been entered 3 times.
- Login error message 2: The message displayed in the dialog box when the maximum allowed login count is exceeded when logging in.

Operation-page style

The webpage operation-page is as shown in the figure below; the data specified in the figure are parts where the style can be changed.

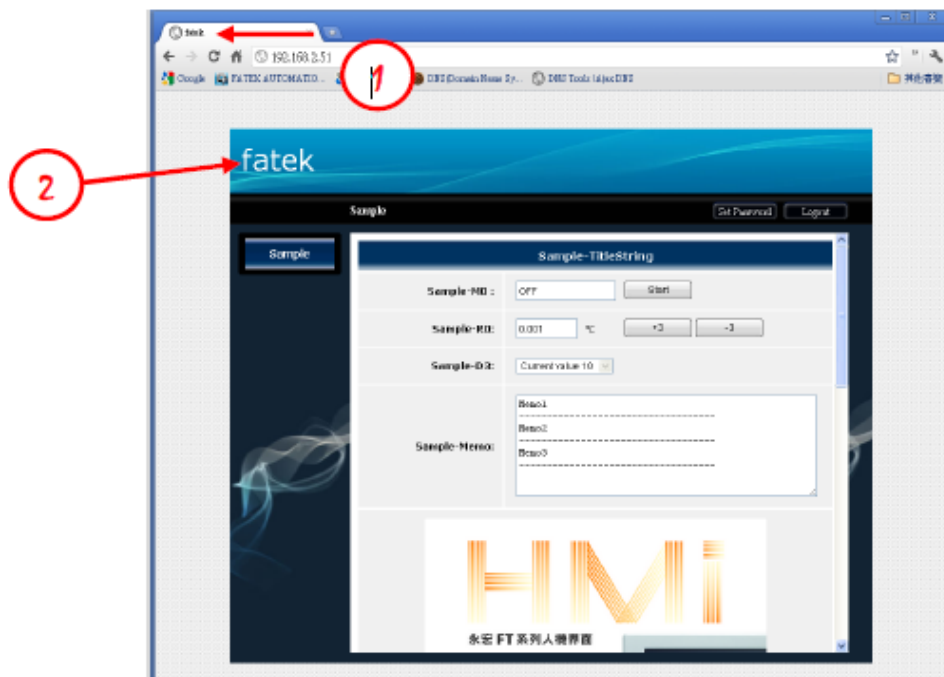

- ① Page title: The title text displayed on the web browser.
- ② Company title: The title text displayed on top of the login screen.

If you want to change the data described above, please follow the following steps to perform the setting:

Step 1, open Easy Web Designer, and double click on “Page Style Setting” on the created project.

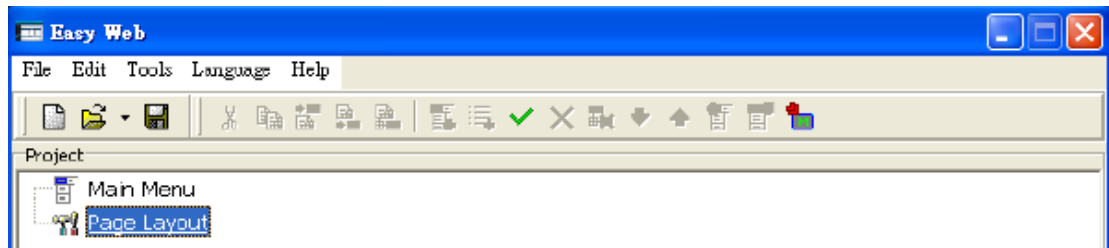

Step 2, after double clicking, the style setting window will appear, click the “login page” tab to perform setting; detailed description of each field are as follows.

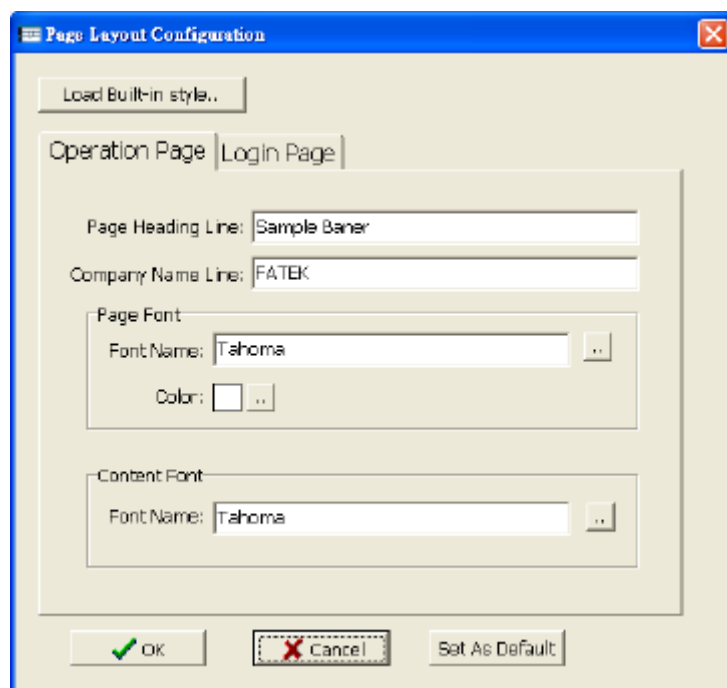

- Page title: The title text displayed on the web browser.
- Company title: The title text displayed on top of the login screen.

When operating, users can enter the string they want to set directly in the field mentioned above, or click the **Load Built-in style button** on top to apply it directly. The default style is selected from default styles provided for the three languages i.e. Traditional Chinese, Simplified Chinese and English.

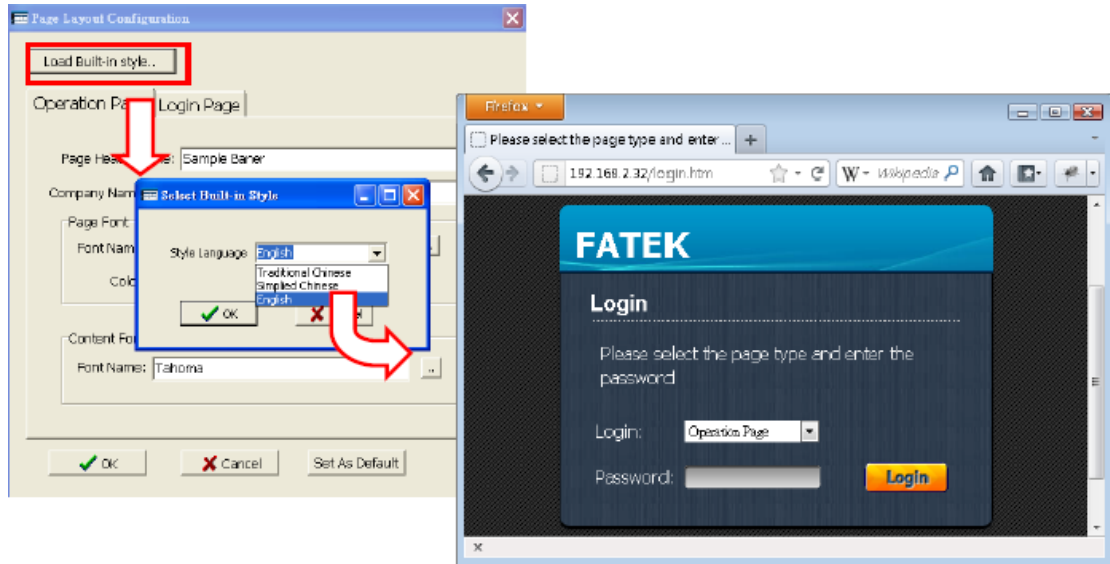





3.1.2 Add Menu

The operation methodology of the customized webpage uses the Multi-level Menu navigation method. Through this method, complicated control operation and contents can be categorized into groups with a systematic and intuitive method to display and further achieving the goal of controlling. The figure below is an example of a user page. The webpage architecture composition includes the “Menu Item” to the left and the “Control Content” to the right, and every menu item is created by a hierarchical menu. A complete menu can have a maximum of two levels, and every level can contain a maximum of 10 menu items. The lowest level is formed by the content items, and the lowest level can contain a maximum of 64 content items. The method to creating a customized web page is as follows:

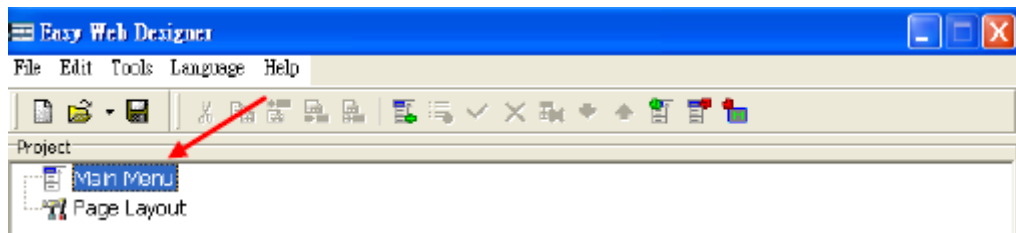
Step 1, add new menu item.

Open Easy Web Designer, and in the created project, click **Main Menu**, at this time a menu editing function button will appear on the toolbar.



- "  "Add menu: Adding new menu items, a two-level button design is provided for the menu, the maximum menu item number for each level is 10.
- "  " Export menu: Export the currently completed designing menu (*.ewm).
- "  " Import menu: Import the completed menu (*.ewm).

In addition, you can also right-click on **Main Menu**, and similarly, the menu editing option will also appear.

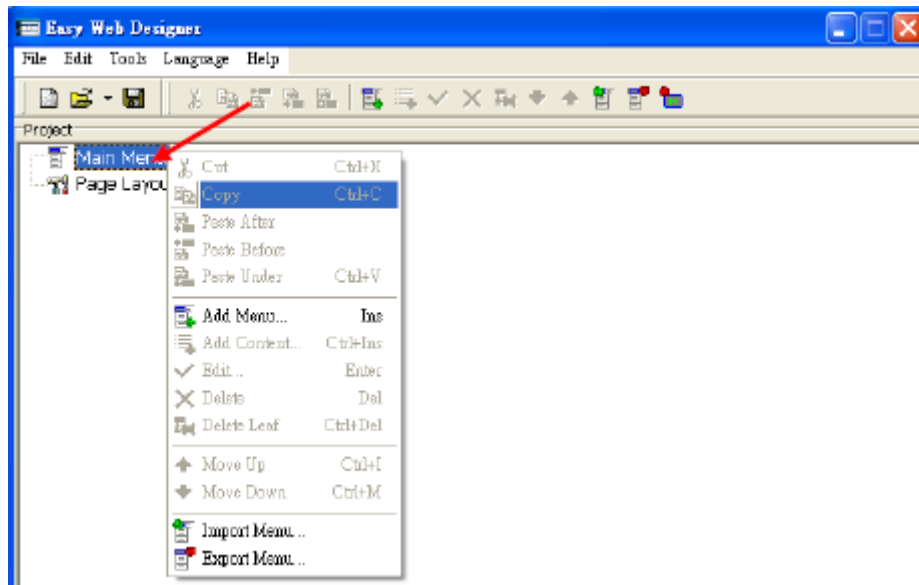

After clicking **Add new menu** with the two methods mentioned above, the following add new menu setting window will appear:

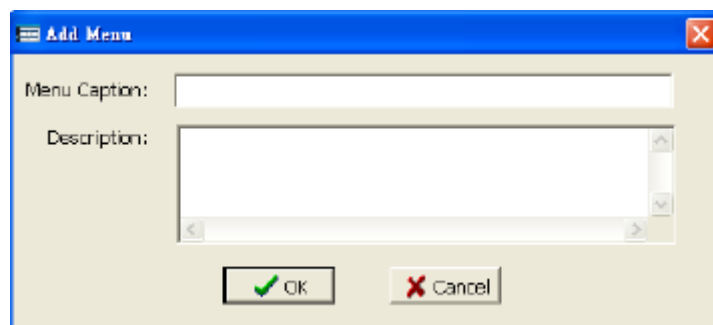

The **Menu Caption** in the add new menu setting window is the menu item text in the web page, and the **Description** part is only a comment in the Easy Web Designer. After filling out the Menu Caption content value, just press OK. As shown in the figure below, the first level menu item is added into the operation menu.

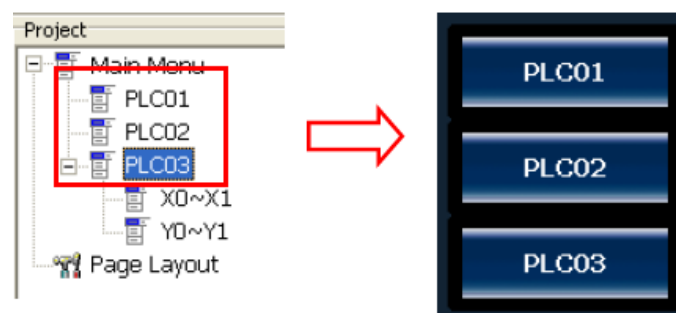

To add a second level sub-menu, just use the mouse and add a new menu in the first level menu just as described above, and as shown below, a sub-menu is added into the first level menu item.

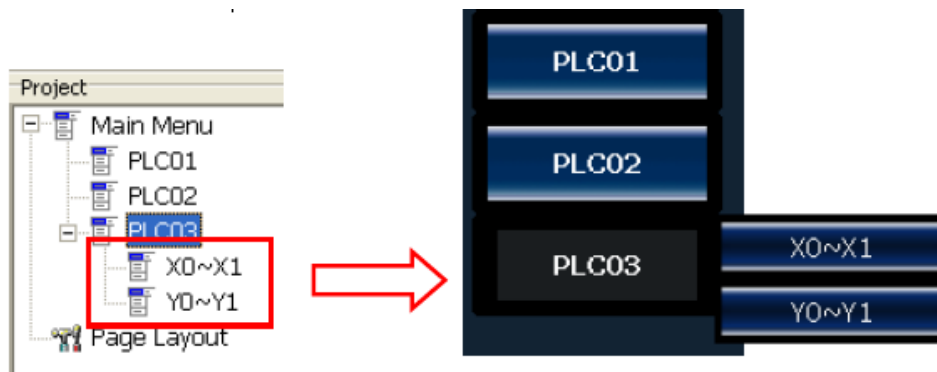

3.1.3 Add Content

After completing the main menu items in Chapter 3.1.2, now you can start creating the control content page to display in every option, and you can add a maximum of 64 content items; the figure below is an example of the control content design, the architecture composition of the control content uses a tabular format to list every control item, and every row represents a control content type.

Y0-Y1	
Y0 :	<input type="text" value="ON"/> <input type="button" value="OFF"/>
Y1 :	<input type="text" value="OFF"/> <input type="button" value="OFF"/>

The adding method of control contents is to click on the created menu; when the menu item is clicked, the “ Add Content” function button will appear on the toolbar. When this toolbar button is pressed the add new content function window will appear; select the content type needed to complete the setting and upload it onto the FBs-CPU module to achieve simple PLC controlling and status monitoring.

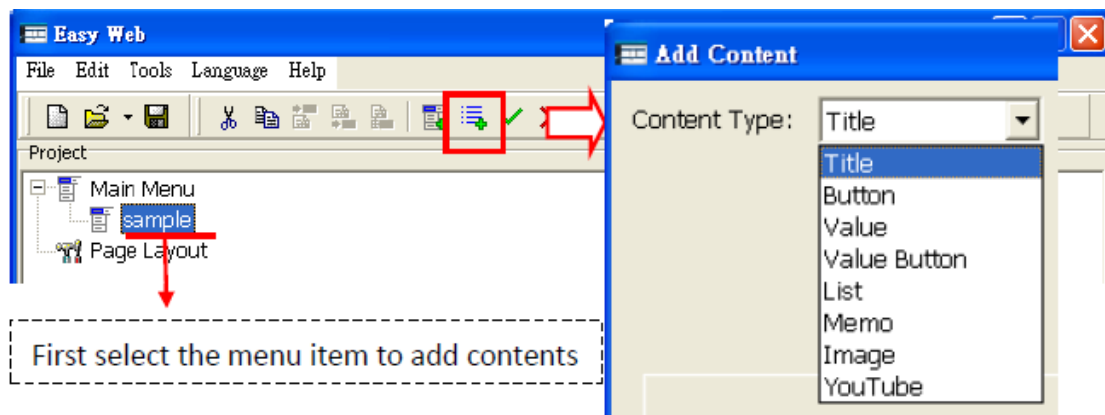

Easy Web Designer provides 8 content items, please refer to the table below for their setting methods:

➤ **Title**

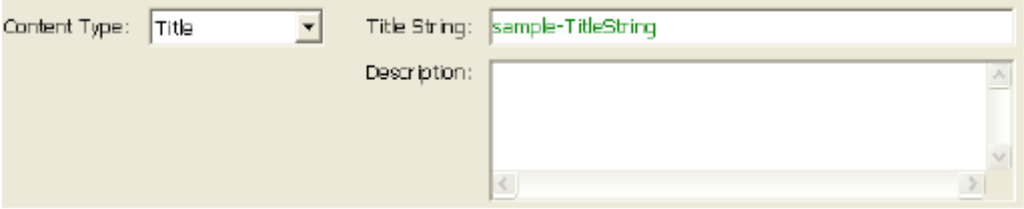
Function Description
Title text used for control item categorization; only used for identification, no actual control contents. When designing, title text can be used to separate control items with different features on the same page for easy identification.
Sample Screenshot

Setting Method
 <p>Content Type: Select "Title".</p> <p>Title String: Fill in the title text to display.</p>

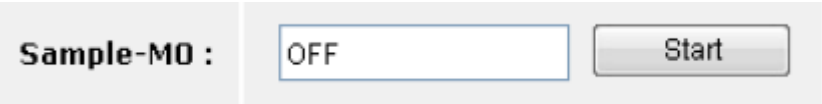
➤ **Button**

Function Description
Used to display and control the on/off state of a contact point.
Sample Screenshot

Setting Method

Content Type: Select “Button”.

Title String: The title description of this button, such as the text displayed in the Sample Screenshot “Example-Button M0 Switch”.

Reference No.: The reference number of contact point to be monitoring. The allowable reference are X, Y, M, S type.

Button Type: There are following buttons can be selected

“Toggle”–Change state for each button press.

“Set On”–Change to on when button press.

“Set Off” –Change to off when button press.

“Momentary On”-Change to on whenever the button is depressed, change to off when button is released.

“Momentary Off”-Change to on whenever the button is depressed, change to off when button is released.

Button Caption: “On State” -the text shown on the button when the contact point is on state. “Off Status Text” -the text shown on the button when the contact point is off state

Status Caption: “On State” the text shown on the value field when the contact point is on state. “Off State” -the text shown on the value field when the contact point is off state.

➤ **Value**

Function Description
Used to display and control the contents of the register
Sample Screenshot

Sample-D0: 0.55 °C

Setting Method

Content Type: Value	Title String: Sample-D0
Reference No.: 00	Description: <div style="border: 1px solid gray; height: 40px; width: 100%;"></div>

Max.: 1000	Decimal Point: 2	<input type="checkbox"/> Signed
Min.: 0	Unit: °C	<input type="checkbox"/> Read Only

Content Type: Select “Value”.

Title String: The title description of this Value item, such as the text displayed in the Sample Screenshot “Example-D0 Status”.

Reference No.: The reference number of the register to be controlled. The allowable reference are R, D, DR, DD type.

Read Only: If this option is not checked, it means that this value item can be altered and the keyboard icon “” will appear, the register’s data content can be modified. If checked, the keyboard icon will not appear and this value item only has the display function; the data content cannot be changed.

Max.: When the control item is in a writable status, this sets the upper limit for the value that could be entered.

Min.: When the control item is in a writable status, this sets the lower limit for the value that could be entered.

Decimal Point: Adda decimal point symbol to the value displayed on the display value; this only displays on the application, it does not have any effect on register content.

Unit: The text is displayed behind the value; normally used to denote the value unit. This only displays on the application, it does not have any effect on controlled register.

Signed: If this box is checked, the value of the register will be interpreted as a number with sign.

➤ **Value Button**

Function Description

Used to display and control the contents of a register; it uses two buttons to modified the value of register. For each press of button, the register's value will be increased or decreased by an amount.

Sample Screenshot

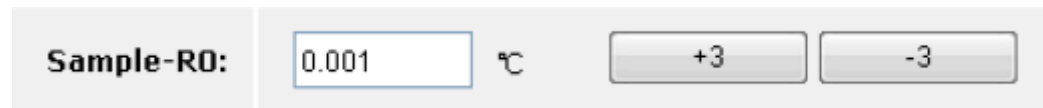

Setting Method

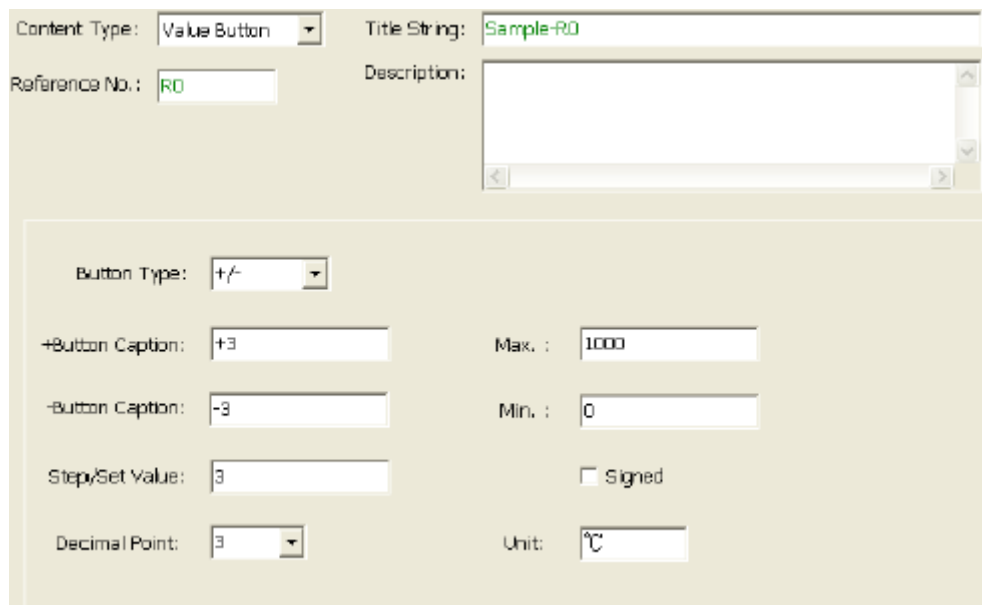

Content Type: Select “Value Button”.

Title String: The title description of this control item, such as the text displayed in the Sample Screenshot “Example-Value Button R0”.

Reference No.: The number of the actual register to be controlled. The allowable reference are R, D, DR, DD type.

Button Type: There are following types can be selected

“Set”-when the button is pressed, the data on the register is set to a fixed value;
“+” when the button is pressed, a fixed value will be added to the data on the register;

“-” when the button is pressed, a fixed value will be subtracted from the data on the register;

“+/-” when a certain button is pressed, a fixed value will be added or subtracted from the data on the register.

+Button Caption: The text that will be shown on the button; when this button is depressed, a fixed value will be added to the register content.

-Button Caption: The text that will be shown on the button. When this button is depressed, a fixed value will be subtracted from the register content.

Step/Set Value: The fixed value, set value, add value, subtract value, add subtract value all use this value as their setting.

Max.: Set this value to restrict the maximum value can be set to the register.

Min.: Set this value to restrict the minimum value can be set to the register.

Decimal Point: Adds a decimal point symbol to the value displayed; this only displays on the application, it does not have any effect on controlled register.

Unit: The text is displayed behind the value; normally used to denote the value unit. This only displays on the application, it does not have any effect on controlled register.

Signed: If this box is checked, the value of the register will be interpreted as a number with sign.

➤ **List**

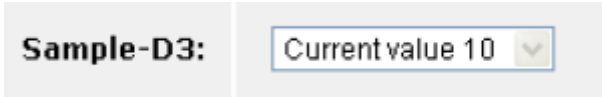
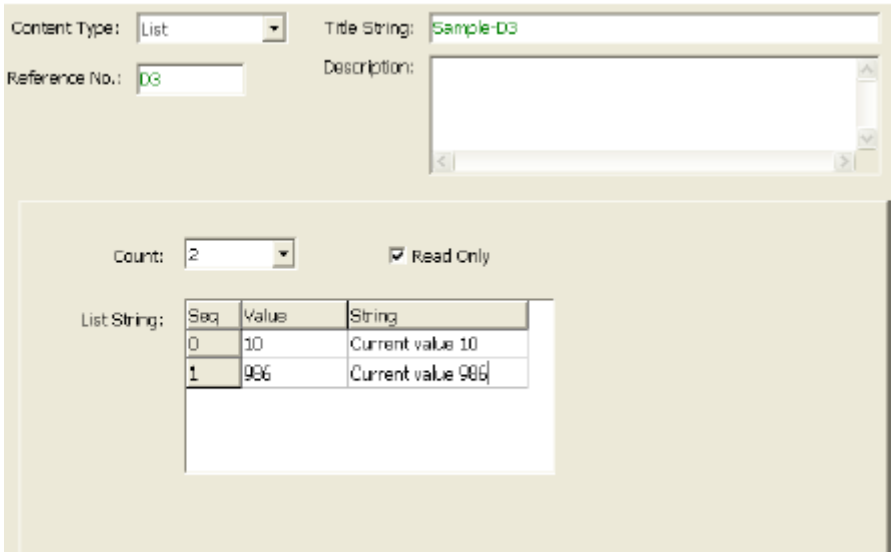
Function Description	
Uses the list item to display and control the value of the register/contact with listed strings.	
Sample Screenshot	
	
Setting Method	
	
<p>Content Type: Select “List”.</p> <p>Usable Reference Number Type: R, D.</p>	

Title Text: The title description of this list item, such as the text displayed in the Sample Screenshot “Example-List D3”.

Reference No: The reference number of the register/contact to be controlled.

Count: Total number of listed strings.

List String:

“Seq” List item number.

“Value”: The value of register to be mapped.

“String”: The string that mapped to the value in value field.

Read Only: If this item is checked, this control item only has the display function; the data content ca not be changed.

➤ **Memo**

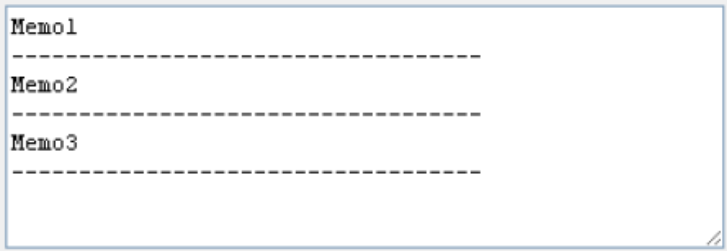
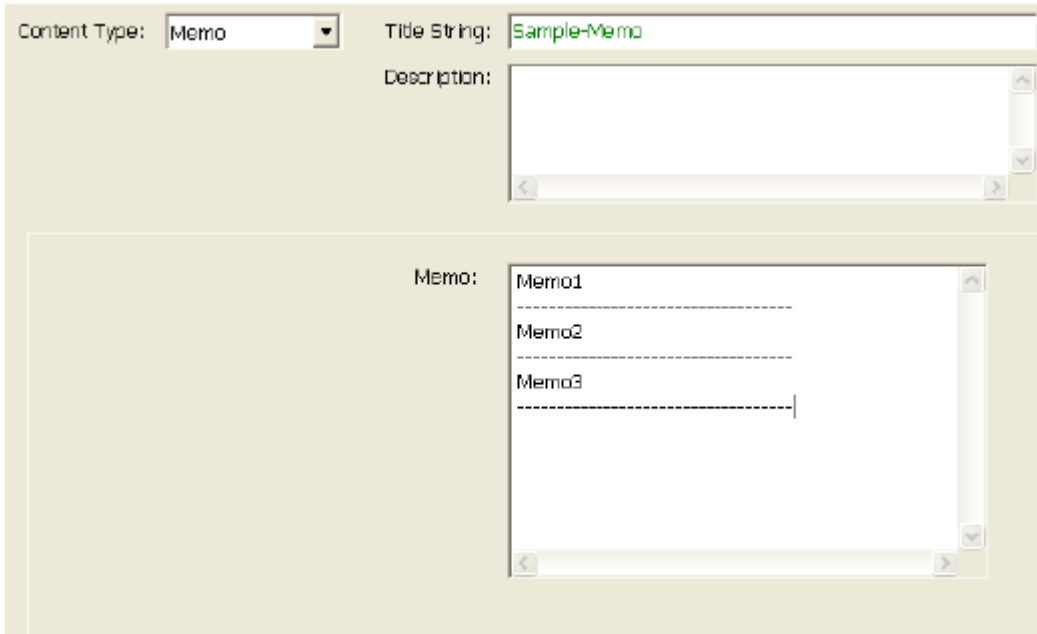
Function Description	
Section to display the description text or comments	
Sample Screenshot	
Sample-Memo:	
Setting Method	
	
Content Type: Select “Memo”.	

Title String: The title description of this memo item, such as the text displayed in the Sample Screenshot “Example-Instructions”.

Memo: Fill in the text to display in the block.

➤ **Image**



Function Description	
The function to add images into the web page.	
Sample Screenshot	
 <p>Sample-Image</p>	
Setting Method	
<p>Content Type: <input type="text" value="Image"/> Title String: <input type="text" value="Sample-Image"/></p> <p>Description: <input type="text"/></p> <p>Image Source : <input type="text" value="C:\FATEK_HMI-03.jpg"/> </p>	
<p>Content Type: Select “Image”.</p> <p>Title String: The title description of this control item, such as the text displayed in the Sample Screenshot “Example-Image”; displays below the image.</p>	

Image Source: Select the file path or image URL of the picture to display in the web page. When this field starts with http:// it means that the image source is a URL.

➤ **Video**

Function Description

Use this function to embed an internet video for playback in the web page. It can be used as an application for machine operation demonstration.

Sample Screenshot



Setting Method

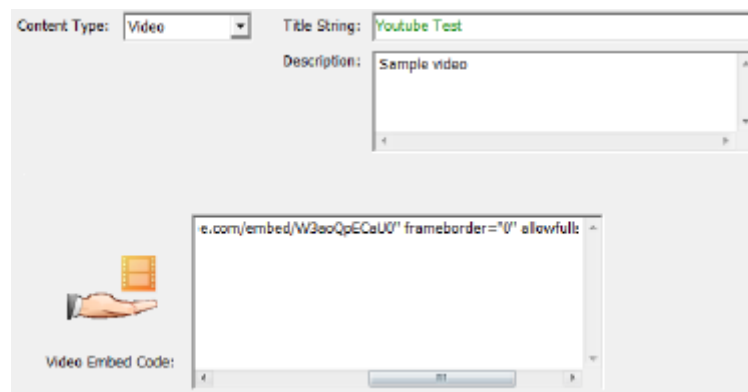

Content Type: Select “Video”.

Title String: The title description of this video item, such as the text displayed in the Sample Screenshot “Example-Youtube Video”, displays below the YouTube video.

Video Embed code: The embedded code that should be included in web content in order to show a video in the web page. While the following example only describe the procedure to get embed code from YouTube, methods for other share video service are similar. First open web browser and go to the YouTube web site and locate the video hosted by YouTube as shown at below.

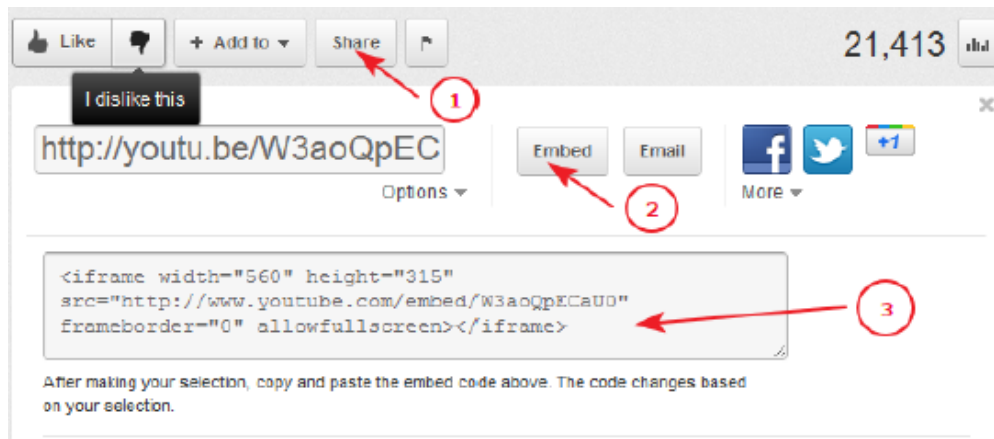

- ① Click share button.
- ② Click Embed button.
- ③ This section will appear after "Embed" button is depressed. Copy the text in this section.
- ④ Paste the copied text into "Video Embed Code" field to finish the embed code entry.

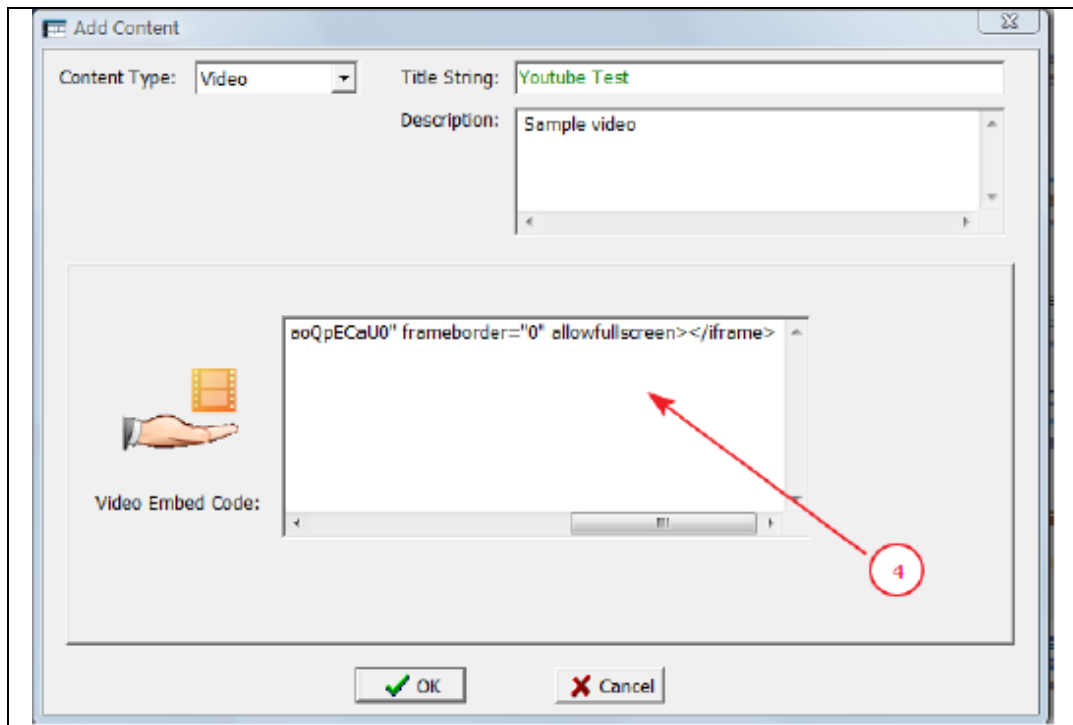

3.1.4 Updating Customized Webpage

After finished creating the menu item and control contents, you must transfer the designed content to the module in order to browse the content of controller based on this design with web browser.

After using the Easy Web Designer to design the navigation menu and its contents, after clicking the toolbar's  download webpage function button, the designed webpage can be transferred to the module.

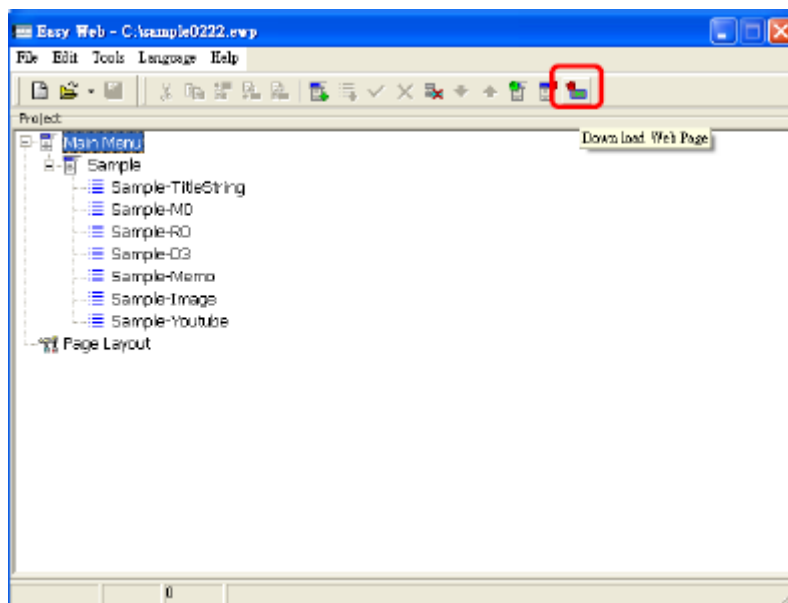

The transfer steps are as described below:

Step 1, confirm the file size of the file to send.

A hint message window will appear before sending, displaying the size of the current designed webpage content; if the content exceeds the maximum capacity (1792KB), it will not be able to download.

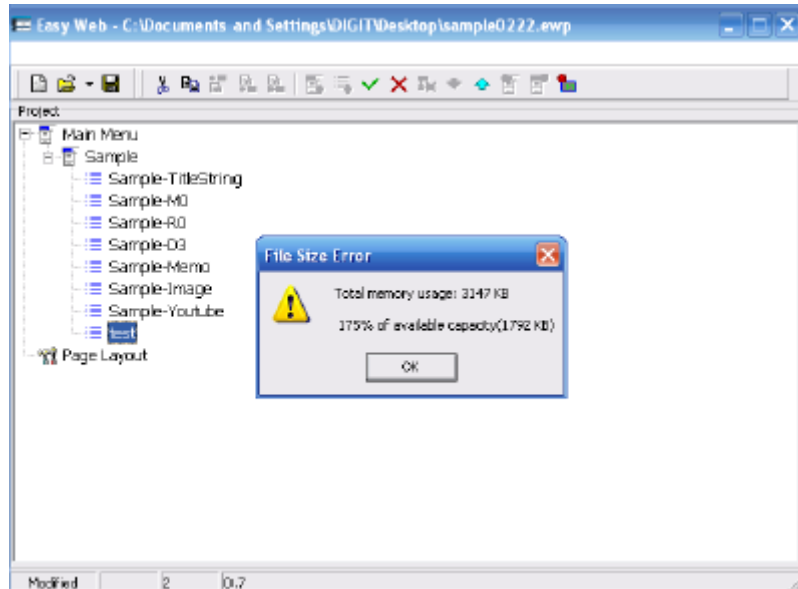

After confirming that the designed webpage content did not exceed the memory capacity, click the **OK** button.

Step 2, target IP and password input.

Before start to transfer the webpage contents, the Web Page Transfer window will appear. Please fill in the IP address for downloading in the “Target IP”, and enter the correct **System Password** in the “Password” field, and then press the **Start Download** button to execute the download.

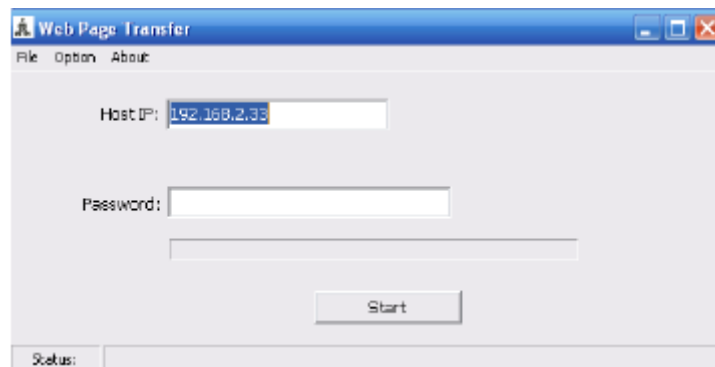

Step 3, confirm the sending progress.

While downloading the current transfer progress will be shown; it is used to confirm whether the transfer is executing normally. When the transfer is complete, the hint message window “File Transfer Done” will appear, indicating that the file transfer is complete.

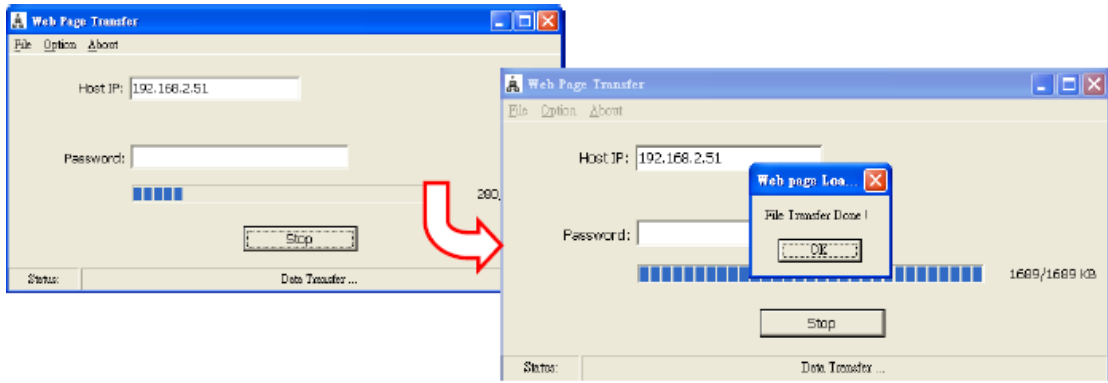

3.2 Sending Emails, Email to SMS

In terms of the maintenance immediacy, this product series provides the Email sending function. When special situations occurred on the workstation, an Email can be sent to notify the maintenance personnel by activating the Email send command code. In addition, through telecommunication companies that provide Email to SMS sending functions, real-time notifications can be achieved using the Email to SMS function. Before sending Emails, a tool “Email Editor” can be used to setup the messages to be sent and the email account information required to send the email. This editor can be opened from “Easy Web Designer” -> “Tools”.



The figure below is the Email Editor window; detailed descriptions of its fields are as follows:

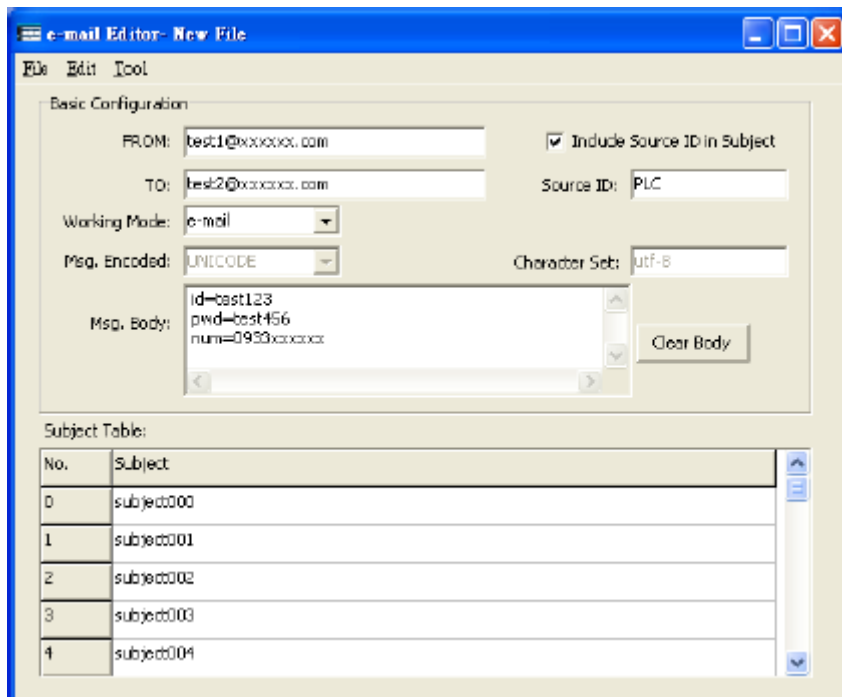

- **FROM:** Just like ordinary Emails, fill in the Email’s sender.
- **Working Mode:** In response to different application methods, the Email Editor provides two sending method settings: “Email” and “Email to SMS”.
- **TO:** Just like ordinary Emails, fill in the address of the recipient to receive this Email; multiple recipients may be entered, such as: jack@mail.com; tom@mail.com. (Note:

When the operation mode is the “Email to SMS” mode, this field is the Email address of each service provider.)

- **Msg. Encoded:** Set according to the operation mode; when in “Email” mode, the coding method is fixed to “UNICODE” and “UTF-8”. And in “Email to SMS” mode, because SMS does not support Unicode, therefore users must pay special attention to the setting. If Traditional Chinese SMS must be sent, the message coding should be set as “ANSI” and the coding character set should be “big5”, this way garbled won’t be generated when the SMS is received.
- **Msg. Body:** Set according to the working mode; in “Email” mode, just like ordinary Emails, fill in the Email content to send. And when the working mode is “Email to SMS”, users must refer to the setting of the service provider that provides the Email to SMS function for this field; the received SMS content is the subject content.
- **Subject Table:** Subject content that can be set as default; when actually sending the SMS, the subject sent is determined by the content of the control register (D3962) when actually sending. If it’s the 0SMS, it uses the 0 subject; if it’s 1 SMS it uses the 1 subject and so on.
- **Include Source ID in Subject:** If this box is checked, the input string in the source ID field will be automatically prefixed to the subject content before sending. The format is [*Source ID*] Subject Content. For example, if the content of the source ID is PLC, then the sent subject will turn into [*PLC*] Subject Content.

By using this function, the source of the message can be identified.

Below we will introduce how to send ordinary Emails and how to send Email to SMS messages.

How To Send Ordinary Email

Step 1, confirm the configuration setting.

Before sending Emails, the SMTP Server address must be filled in the IP (URL) field.

Fill in your login name and password of SMTP Server.

SMTP Server	
SMTP Login Name	
SMTP Login Password	
SMTP IP (URL)	msa.hinet.net
SMTP Port	25

- **Login Account:** SMTP Server account.
- **Login Password:** SMTP Server password.

Note	
	1. Nowadays, most of the sending and receiving of emails through the SMTP protocol are achieved through encryption. The FATEK network module

series does not yet support encryption. Therefore, if users want to use this function, they must first confirm whether the server supports no encryption.

Step 2, open the Email Editor and set the Email sending information.

Just like ordinary Emails, fill in information such as the Email's recipient, Email body and subject content etc.; if you want to add source ID before the subject, you can check the "Include Source ID in Subject" option.

The screenshot shows a 'Basic Configuration' dialog box with the following fields and options:

- FROM: abc@hotmail.com
- TO: william@fatek.com
- Working Mode: e-mail (dropdown)
- Msg. Encoded: UNICODE (dropdown)
- Msg. Body: test (text area)
- Character Set: utf-8
- Include Source ID in Subject:
- Source ID: PLC
- Clear Body button

Below the dialog box is a 'Subject Table' with the following content:

No.	Subject
0	test 000

Step 3, download the Email configuration previously set

After completing the basic Email settings, this information must be uploaded to the module. Click "Tools" -> "Download e-mail configuration" from the main menu.

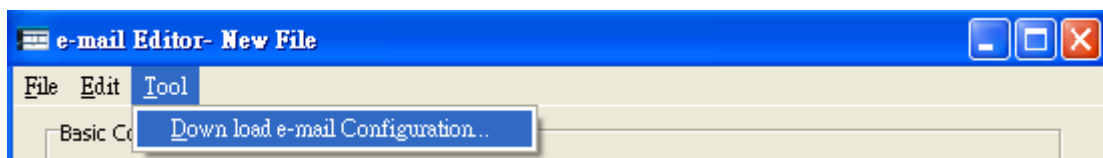

The "Email Configuration transfer" window will appear at this time; in the "Target IP" field, fill in the IP address to download the information, then confirm that the correct password is entered in the "Password" field and press the "Start Download" to perform the downloading.

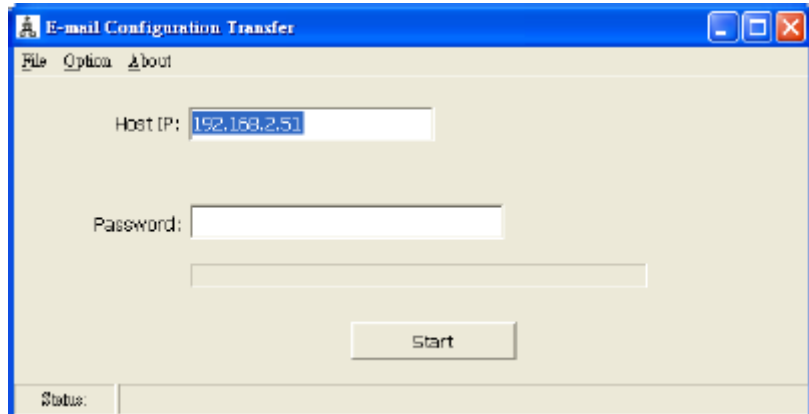

Step 4, Execute Email sending in the ladder program

After completed downloading the Email configuration, the Email sending function can be used; the figure below is a simple control program which uses one contact to set the Email command code register D3961's value as 0x3370, then it will execute Email sending. In addition, register D3962 can be used to control the subject number to be sent. To use the Email sending function and performing control through registers D3961~D3963.

Note	
	<p>Every time an email is sent, the command content value of D3961 must be set back to zero before it can continue to accept new sending commands.</p>

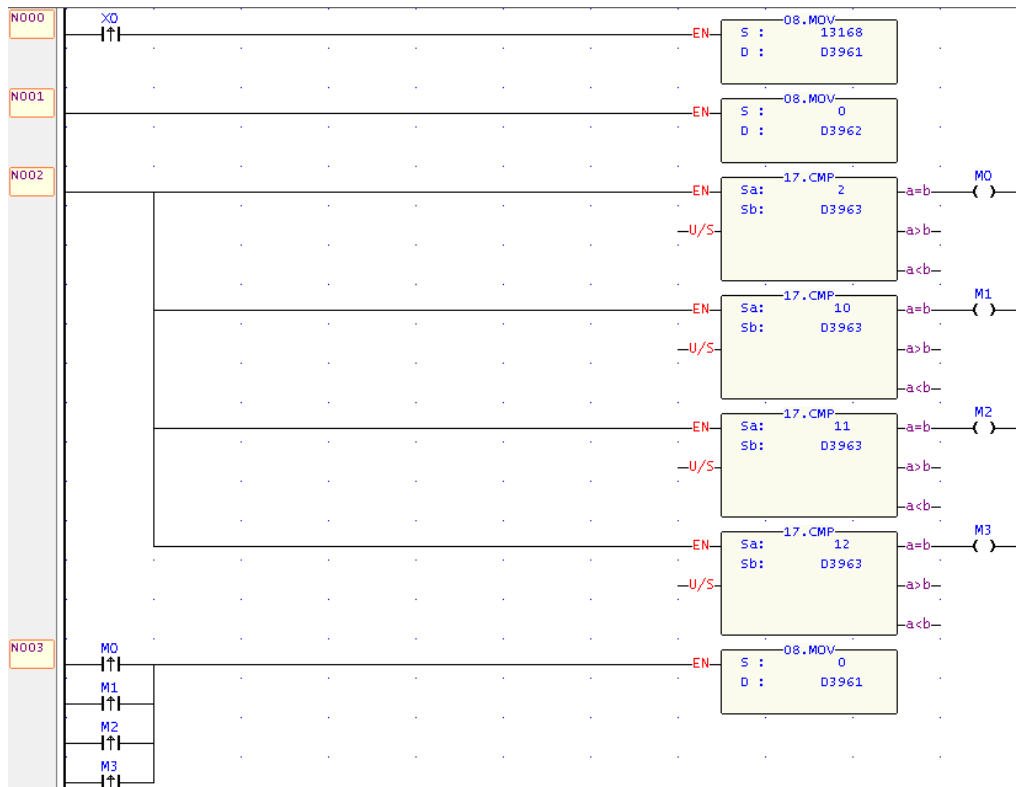

After completing the steps mentioned above, every time X0 changes from 0 to 1, and when D3962 is 0, it will receive the Email.

How to use Email to SMS function

Step 1, confirm the configuration setting.

Before sending Emails, the SMTP Server address must be filled in the IP (URL) field.

SMTP Server	
SMTP Login Name	
SMTP Login Password	
SMTP IP (URL)	msa.hinet.net
SMTP Port	25

Step 2, open the Email Editor and set the Email to SMS information.

To use Email to SMS, you must go through service providers that provides Email-to-SMS services; Here we use Message Media as an example: <http://www.message.com.tw>

As shown in the figure below, in the recipient field (TO), fill in the account for Email to SMS provided by the service provider; please refer to the format provided by the service provider for the Email body. For Message Media, the information needed to be entered in the Email body are service account, service password, and the mobile phone number that is going to receive the SMS. (Note: Under Email to SMS mode, the SMS content received by the mobile phone is the subject content.)

Note	
	1. In the mode of email to SMS, the content of the SMS received by the mobile phone is the subject content.

Basic Configuration

FROM: Include Source ID in Subject

TO: Source ID:

Working Mode:

Msg. Encoded: Character Set:

Msg. Body:

Subject Table:

No.	Subject
0	subject000
1	

Step 3, Transfer the Email configuration

After completing the basic Email settings, this information must be sent to the module.

Click “Tools” -> “Download Email configuration” from the main menu

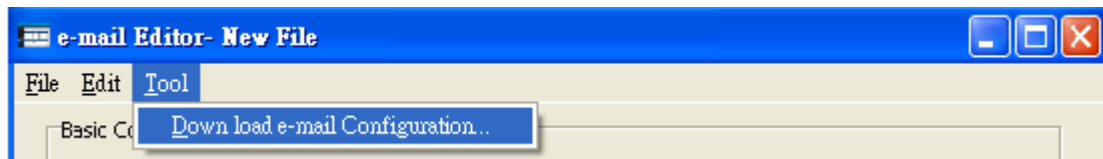

The “Email Configuration transfer” window will appear at this time; in the “Target IP” field, fill in the IP address to download the configuration, then confirm that the correct password is entered in the “Password” field and press the “Start Download” to perform the downloading.

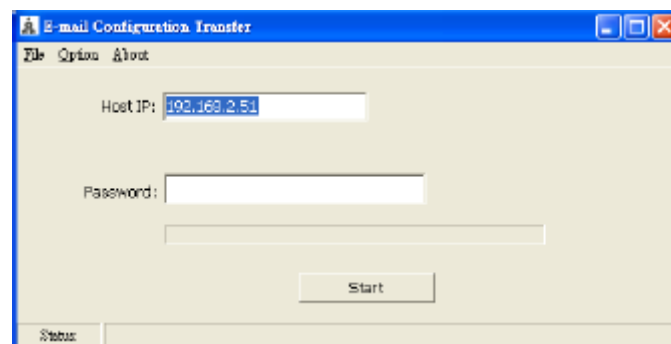

Step 4, Execute Email sending in the ladder program

After completed uploading the Email configuration, the Email sending function can be used; the figure below is a simple control program which uses one contact to set the Email command code register D3961's value as 0x3370, then it will execute Email sending. In addition, register D3962 can be used to control the subject number to be sent. To use the Email sending function and performing control through registers D3961~D3963.



After completing the steps mentioned above, every time X0 changes from 0 to 1, and when D3962 is 0, the mobile phone will receive the SMS.

3.3 Internet Clock Synchronization

This product series provides the internet clock synchronization function; its main goal is to eliminate the problem of manually correcting the time on a regular basis. After the internet clock synchronization function is enabled, the system will get the standard time from the internet time server (NTP server) set by the user every 10 minutes. If the user needs to use the clock synchronization function, it can be set through the Ether_Config software or open the browser and enter the built-in system page to perform the settings.

3.3.1 Enable the Internet Clock Synchronization Function

The steps to enable internet clock synchronization function through the Ether_Config software are as follows:

Parameter	Value
➤ NTP Server	
NTP Enable/Disable	Enabled
IP (URL)	clock.stdtime.gov.tw
NTP Time Zone	GMT+8

Steps to enable internet clock synchronization function through a web browser areas follows:

- ① Open the web browser and enter the IP address.
- ② Select the system page and enter the password to log in (Please refer to Chapter 3.2 for detailed operation steps)

The screenshot shows the 'External Servers' configuration page. On the left sidebar, the 'Servers' menu item is circled in red with a '3'. The main content area shows the 'External Servers' configuration. The 'NTP IP(URL):' field is checked and contains 'time-a.nist.gov', and the 'Time Zone:' dropdown is set to 'GTM +8:00'. These two fields are circled in red with a '4'. A red arrow points from the '4' to the 'NTP IP(URL):' field. Other fields include DNS Server 1 (168.95.1.1), DNS Server 2 (168.95.1.2), SVC IP(URL) (192.168.2.19), SVC Port (5700), and SMTP Server (msa.hinet.net). Buttons for 'Apply' and 'Undo' are at the bottom.

- ③ Select the Servers setting page.
- ④ Check the box to the right of NTP Server and enter the internet time server IP address and time zone.

3.3.2 Synchronization of Real Time Clock with Network Time

When using a FBs-PLC with built-in Real Time Clock, the user can use the clock synchronization function to keep the calendar time accuracy within 1 second that eliminates the trouble of manually correcting the time on a regular basis. The figure below depicts the relation between the module time register, PLC's internal special register and the RTC, the user only needs to move the contents of the module time register to the special register within the PLC and use M1952 to control the time synchronization:

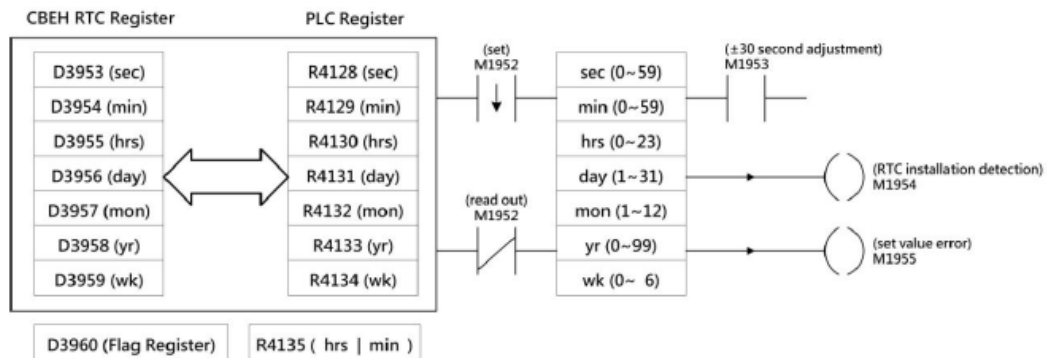

3.3.3 Sample Application

This product series reads the standard time from the internet time server once every 10 minutes. Each time when receives a new data, it will increment the value of D3960 flag register and simultaneously update the contents of other calendar registers. The status change feature of the D3960 flag register can be used to control M1952 to perform data movement and RTC setting or reading. The following is a sample ladder program and its description:

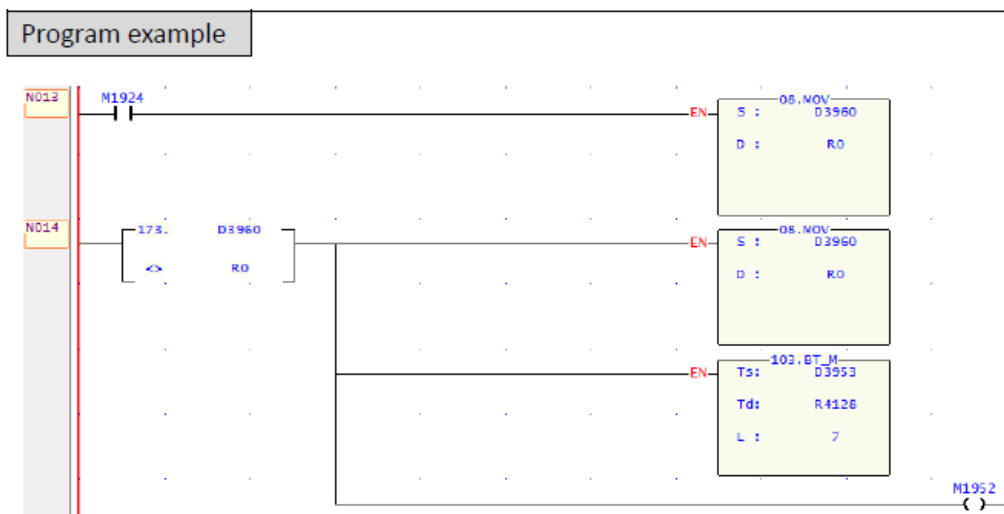

The program compares the content of R0 and D3960 to detect the changes in D3960; every time D3960 changes, the comparison output will enable the movement of the contents of D3953~D3959 to R4128~R4134 and set the value of R0 to the same as D3960 in preparation for the detection of the next D3960 change. When scanned the next time and the contents of R0 and the D3960 register is the same, therefore the comparison output is again changed of OFF and the M1952 also changes to OFF. The action of controlling M1952's status to change from ON to OFF will write the newest time in R4128~R4134 into RTC, therefore achieving the goal of automatic time synchronization.

3.4 Monitoring PLC's Internal Status Using System Webpage

This product series provides the function to monitor the status of the PLC with web browser. To use this function, open a web browser and connect to the module, select system page and login, then click the PLC Status page to see the following screen:

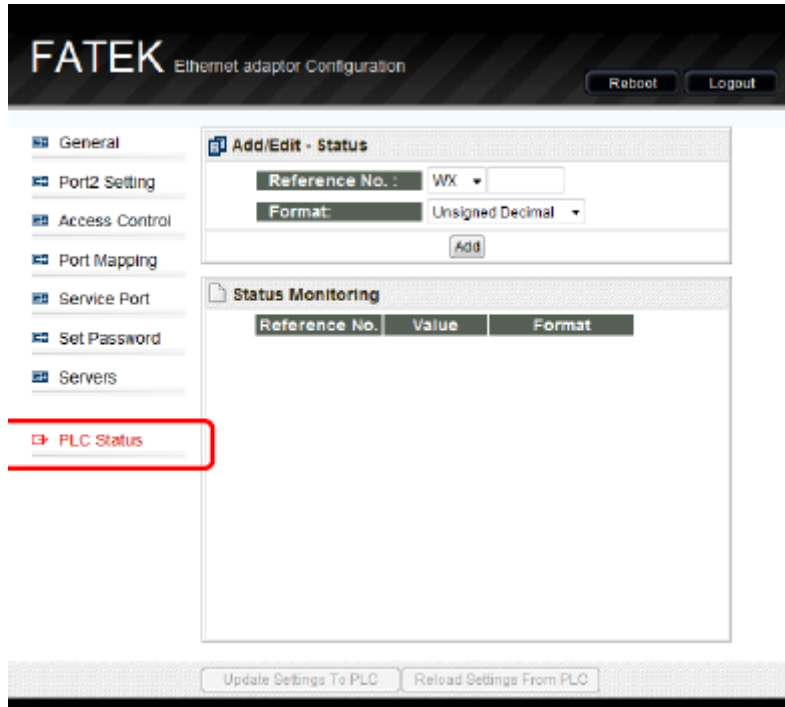

The status monitoring page as the following features:

- The data display format can be in three forms: positive or negative integers (Signed Decimal), positive integer (Unsigned Decimal) and Hexadecimal.
- It can monitor up to 5 registers/contacts at one time.
- When communication is normal there is a communication signal icon: red means sending, green means receiving; when communication is normal, the red light and green light will flicker simultaneously, if no response message is received, only the red light will flicker.

3.4.1 Adding Monitoring Points

To add new monitoring points, in the Add/Edit-Status field, enter the point information and then press the **Add** button:

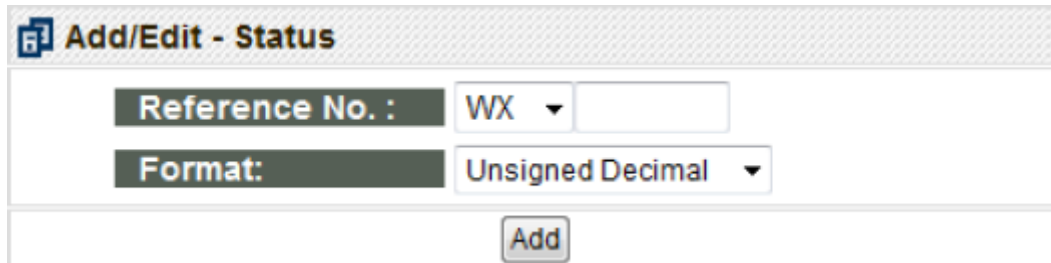

Add/Edit - Status

Reference No. : WX

Format: Unsigned Decimal

Add

- Reference No.: The reference number of the monitored point.
- Format: Data format; can be set to positive or negative integers (Signed Decimal), positive integer (Unsigned Decimal) or Hexadecimal.

When the new point is added, the newly added data can be seen in the Status Monitoring field, as shown in the figure below:

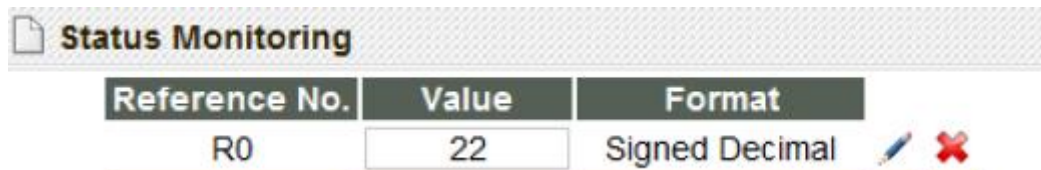



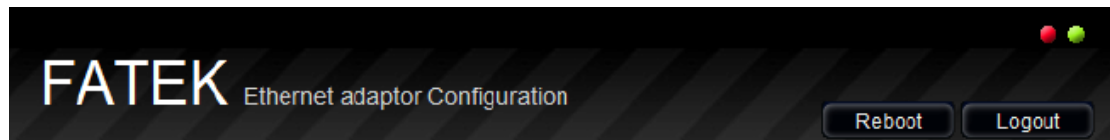

Reference No.	Value	Format
R0	22	Signed Decimal

You can also notice that the communication signal on the top-right of the webpage will start to flicker, this means that the communication status with the PLC is normal:



3.4.2 Modifying and Deleting Monitoring Points



To modify a monitoring point, click the  button behind that point in the Status Monitoring field, the icon is to modify; when pressed, the icon will change to  and the highlighted parts will turn red, then you can edit the **Add/Edit-Status** field on top and then press the **Apply** button to complete the modification. To delete a point, please directly press the  button to delete that corresponding data entry.

 **Add/Edit - Status**

Reference No. :	R	▼	0
Format:	Signed Decimal ▼		

Apply

 **Status Monitoring**

Reference No.	Value	Format		
R0	22	Signed Decimal		

3.4.3 Modify the Value of Monitoring Point

To control the monitoring point content, first move the mouse cursor to the **Value** field of the point you want to control and click the left button. The following pop-up window will appear:

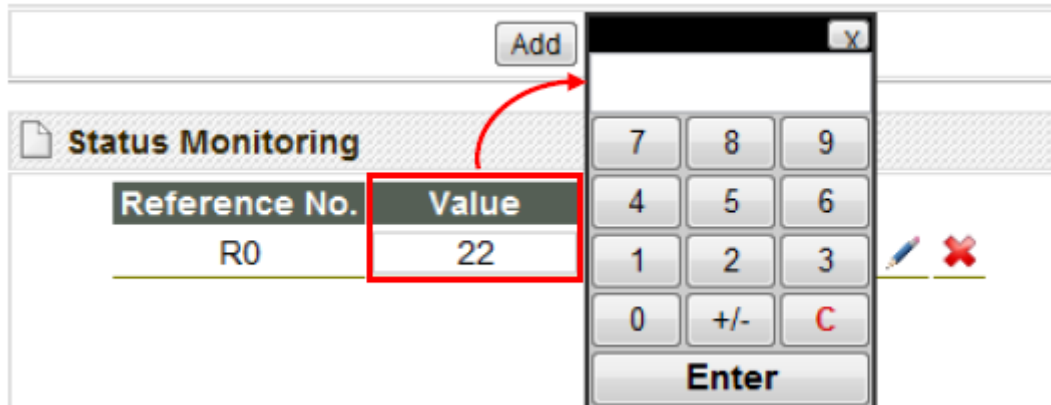

Here different pop-up windows will appear according to the data type and display formats; there are total of three types as shown below:

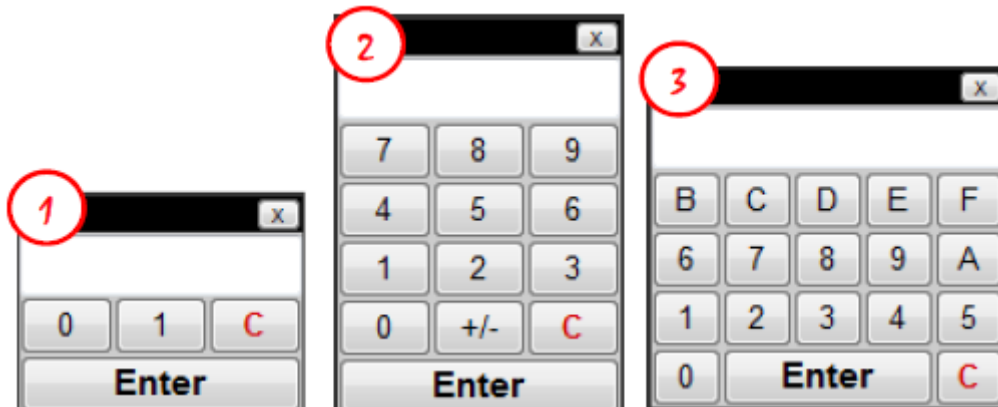

- ① When the monitoring point is a contact type such as X, Y, M, this window will appear; it can only be set to 0 or 1.
- ② When the monitoring point is a positive or negative integer or positive integer, this window will appear.
- ③ When the monitoring point is hexadecimal, this window will appear.

If the user wants to modify the value content, input the data in the popped-up window and then press the Enter button to complete the modification of the content of that point.

3.5 Active Call Back

Service Call Center (hereinafter referred to as SVC) is a remote maintenance software; when the PLC workstation's IP address is acquired using dynamic IP or if it's behind a firewall and access from outside is difficult, this software can be used to simplify the maintenance operation.

The application architecture of active call back is as shown in the figure below; it uses one computer to execute the SVC software as the maintenance center. When a workstation equipped with this product series executes active call back(①), it will send a connection request (②)to the maintenance center according to the configuration setting; the maintenance center will confirm the workstation's connection request (③)and then the application program(such as Winproladder)can be automatically opened through this connection to carry out the maintenance operations(④).

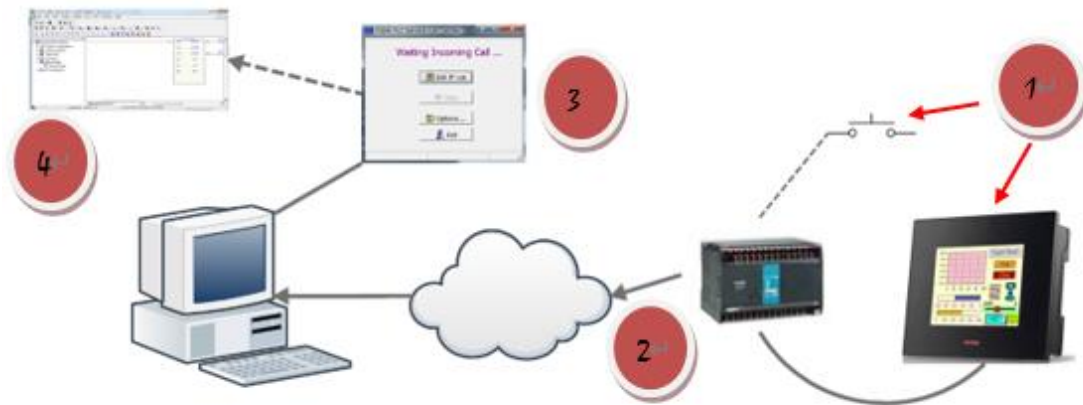

3.5.1 Option Setting Page

When applied; a computer with a fixed IP address must be set as the maintenance center and the basic settings for the Service Call Center must be completed on the maintenance center. The figure below is the option setting page when the **options** button is pressed after Service Call Center is opened; the definition of each field are as follows:

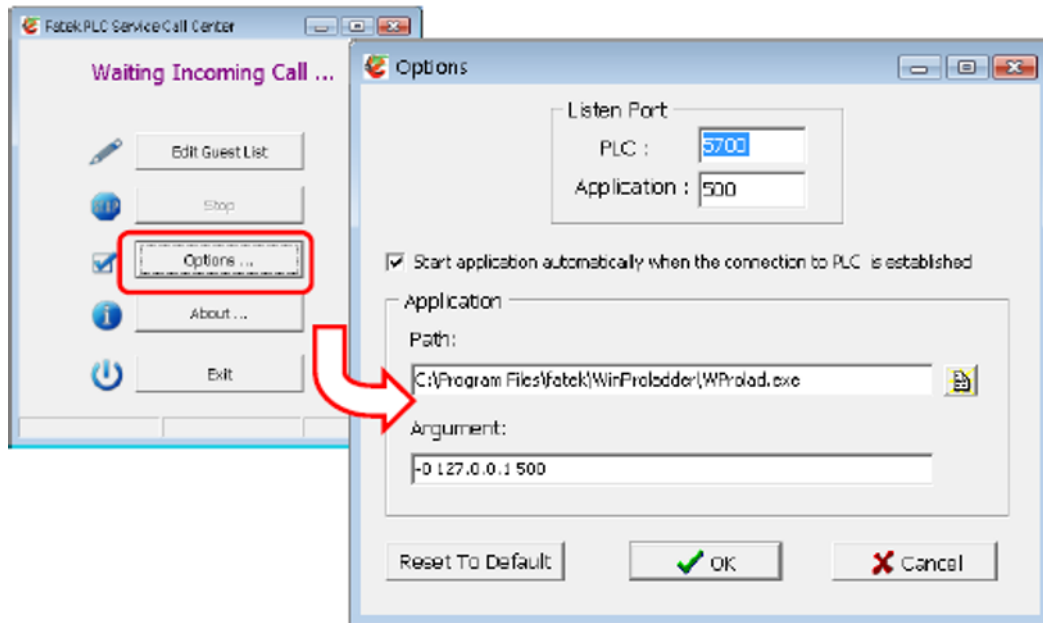

- Listen Port –PLC: Specify a communication port as the maintenance center’s external service port; the default value is 5700.
- Listen Port –Application: Specify an IP port number as the application software’s external service port. If it’s the Winproladder application software, it is set to 500.
- Start Application Automatically ...: When the workstation and maintenance center has successfully connected, if the application program needs to be automatically started up, this option must be checked.
- Application –Path: When the workstation and maintenance center has successfully connected, if the application program needs to be opened, the path of the application program to be opened must be entered here.
- Application –Argument: If additional command parameters need to be added when opening the application program, enter it in this field.

The default content of this page is set when the application program is Winproladder. Unless there are other application considerations, there are no need for modifications to the contents of this page.

3.5.2 Guest List

The main function of the guest list is when a connection request is received, a maintenance center personnel connection source identification can be provided at first time to use as a basis for follow-up processing; a simple example is shown in the figure below. First click the **Edit Guest List** button, then right-click in the guest list to add a workstation information entry; the definition of each field are as follows:

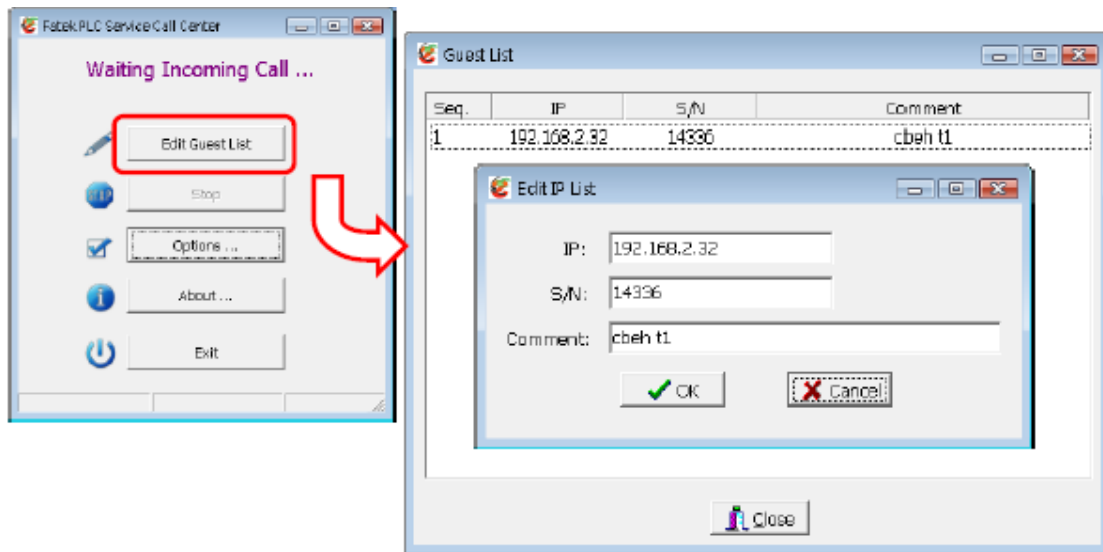

- IP: The network address of the workstation requesting connection.
- S/N: The factory serial number.
- Comment: The text description information of the corresponding remote workstation, such as company name and machine model number etc.

When the guest list is created, the following two figures are two connection requests received by the maintenance center from different IP workstations. The contents of the IP, Description and S/N fields are provided by the workstations when connecting; and the contents of Comment are the information look up from the guest list that uses the factory serial number as the key value. In the left figure below, the connection request shows that its manufacturing serial number is 14336 and is listed in the guest list, and its IP is the same as the data created, therefore the color of the displayed information are all black; on the other hand, the serial number of the connection in the right figure below is 14336 and is listed in the guest list, but its IP is 192.168.2.32 which is different from the registry information, therefore the IP information is displayed in red as a reminder.

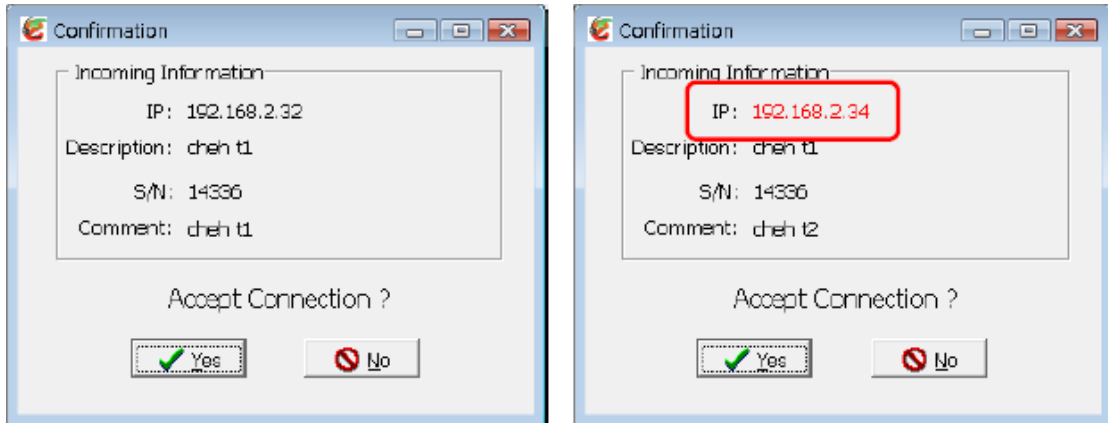

When the connection request window appears, the maintenance personnel can press the **Yes** button to accept this connection or press the **No** button to reject this connection.

3.5.3 Active Call Back Application Example

The steps to execute the active callback function are as follows:

Step 1, setting up the maintenance center environment

In an active call back application, first a PC with static public IP must be used as the maintenance center, then execute the SVC software to complete the basic settings on the option setting page; at this time, the maintenance center is in ready status.

Step 2, Configuration setting

The content of the Service Call Back Server configuration in this remote module where you want to execute active call back must be the same as the one in the maintenance center, in order to establish the communication between the workstation and the maintenance center.

Service Callback Server	
Service Callback IP (URL)	
Service Callback Port	5700

Step 3, execute the active call back program

After confirming that the workstation's Service Call Back Server configuration setting is correct, you can execute the active call back function. To use the active call back function, it can be controlled using the registers D3950 and D3951.

The next figure is a simple control program; it uses the X0 contact to start up the active call back action. When X0 is pressed, the active call back command code register D3950 will be set to 3359H, which will execute the active call back. In addition, the status of register D3951 can be used to monitor the operation execution of the call back. In the example, when the connection is successful, Y1 will be ON. When connection failed, Y2 or Y3 will be ON. When connection is terminated, D3951 must be set to 0 in order to accept the new call back request command.

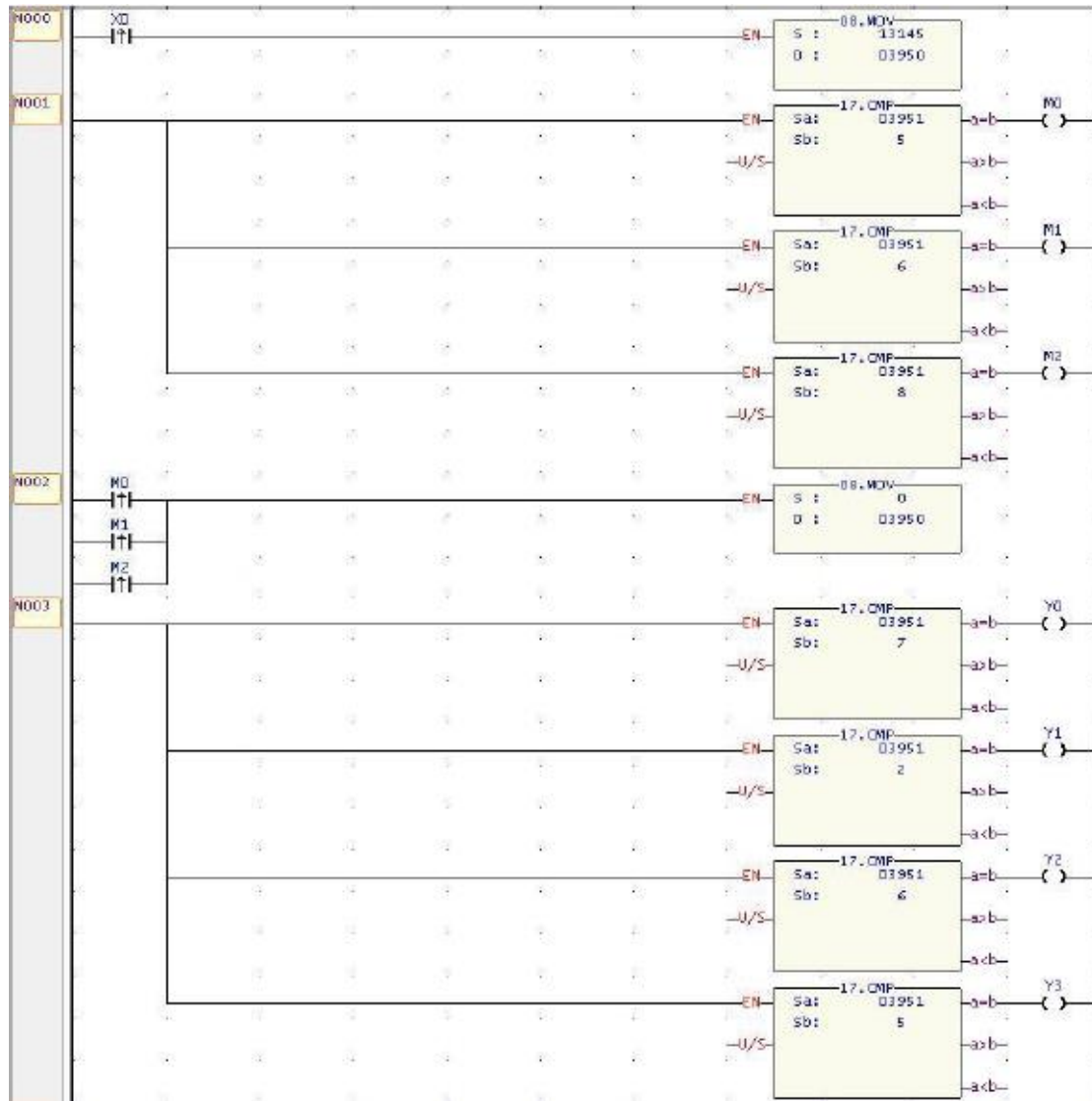

Step 4, confirm connection request

After the workstation sent out the active call back command, the connection request information will be displayed at the maintenance center. At this time, the maintenance center can decide whether to establish the connection with the workstation and start up the application program.

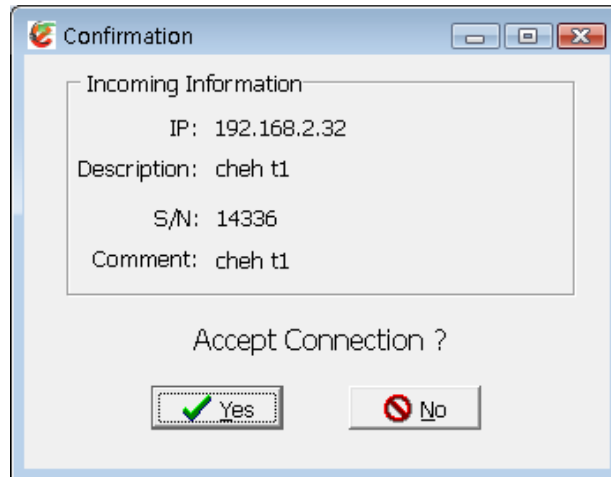

3.6 FATEK IoT Service (iMonitor, iLocation)

3.6.1 IoT Service Description

Before using FATEK IoT service, user needs to submit application to FATEK to obtain Customer ID and User Admin to log in to website for manage system configuration.

iMonitor

- There are multiple HMI and PLC scattered in different areas and the data on these devices should be monitored at the same time.
- Set alarm conditions to specific register address, if conditions are met then SMS or email can be sent to the user admin for on-site troubleshooting.
- If you want to analyze the time or the data changes, record the data and acquire the system status through the historic trend.
- No need to redownload the HMI project, can configure and modify the register address through browser.
- Adjustable device returning time interval or return when changed, can reduce the use of network bandwidth.

iLocation

- GPS location information can be set on the device, and can view the distribution location of the device.

3.6.2 Activate Devices

Select the corresponding website for different market needs

World Wide User	https://fatekcloud.net
China User	https://fatekiot.cn

Enter the website and login the account.

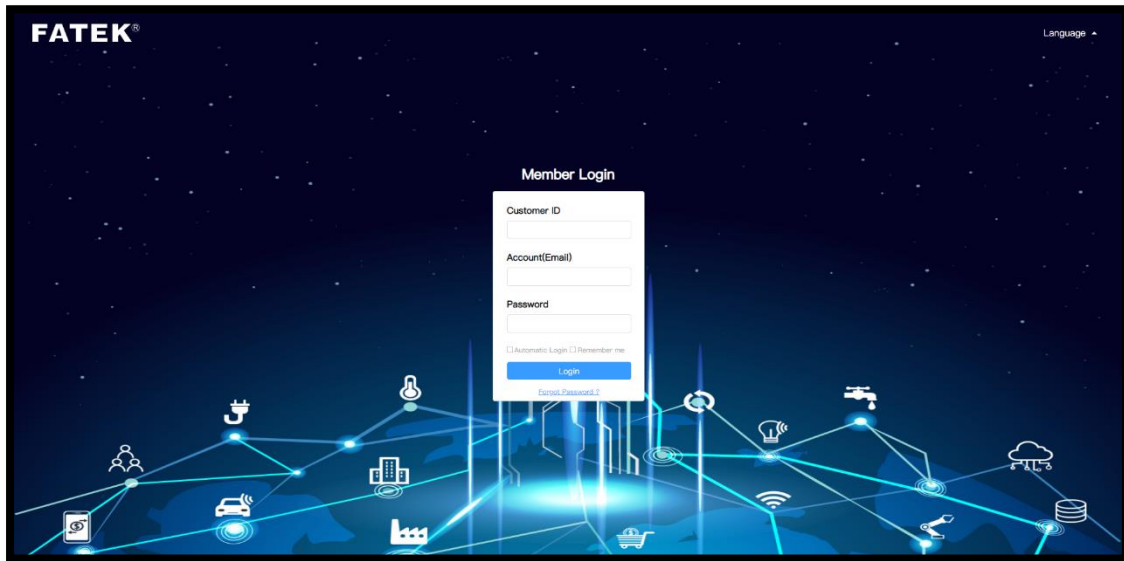

Before establishing the iMonitor connection, enter the module IoT service settings, and enter the HWID and password on the web setting page.

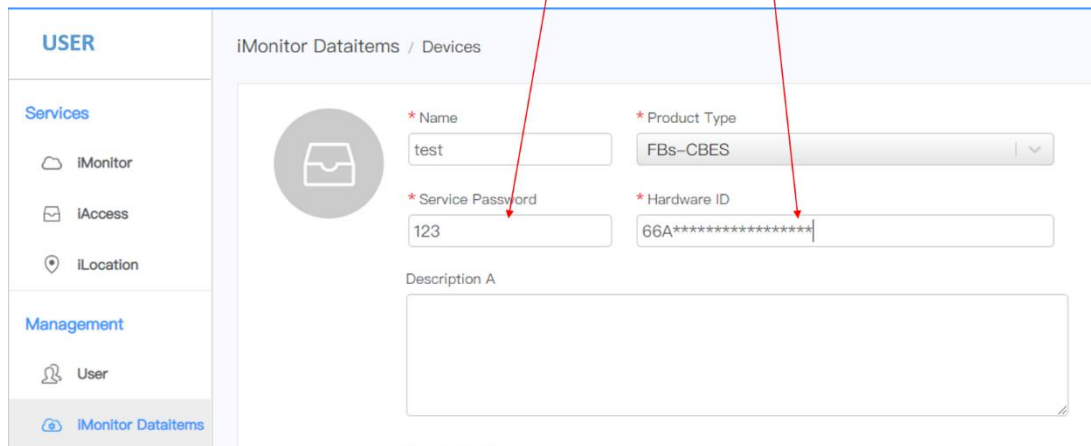
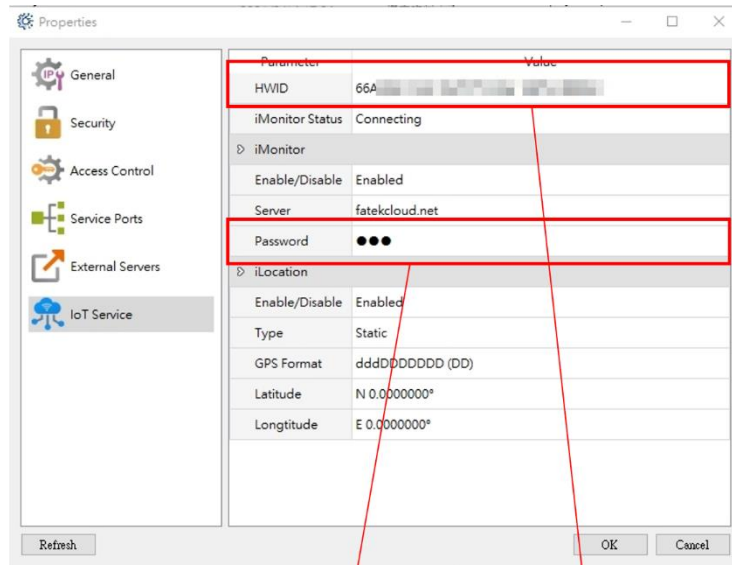

Note	
	<ol style="list-style-type: none"> 1. After the HWID and password are matched with the module on the website then the connection status can be confirmed. 2. For detailed IoT description, please refer to the IoT User Manual.